

JOURNAL 07

The Ultimate Machining Power



THE ULTIMATE MACHINING POWER
GOODWAY[®]
GOODWAY MACHINE CORP.

Rise of Intelligence Revolution in Manufacturing

Paving your way to success in industry 4.0 —

The new generation CNC System "G.LINC 350" incorporates powerful intelligent machining technology for our Goodway Turning Centers and simplifies and optimizes the process in an intensive and efficient manner. GOODWAY MACHINE CORP. collaborates with you to meet new manufacturing challenges for the 21st century.



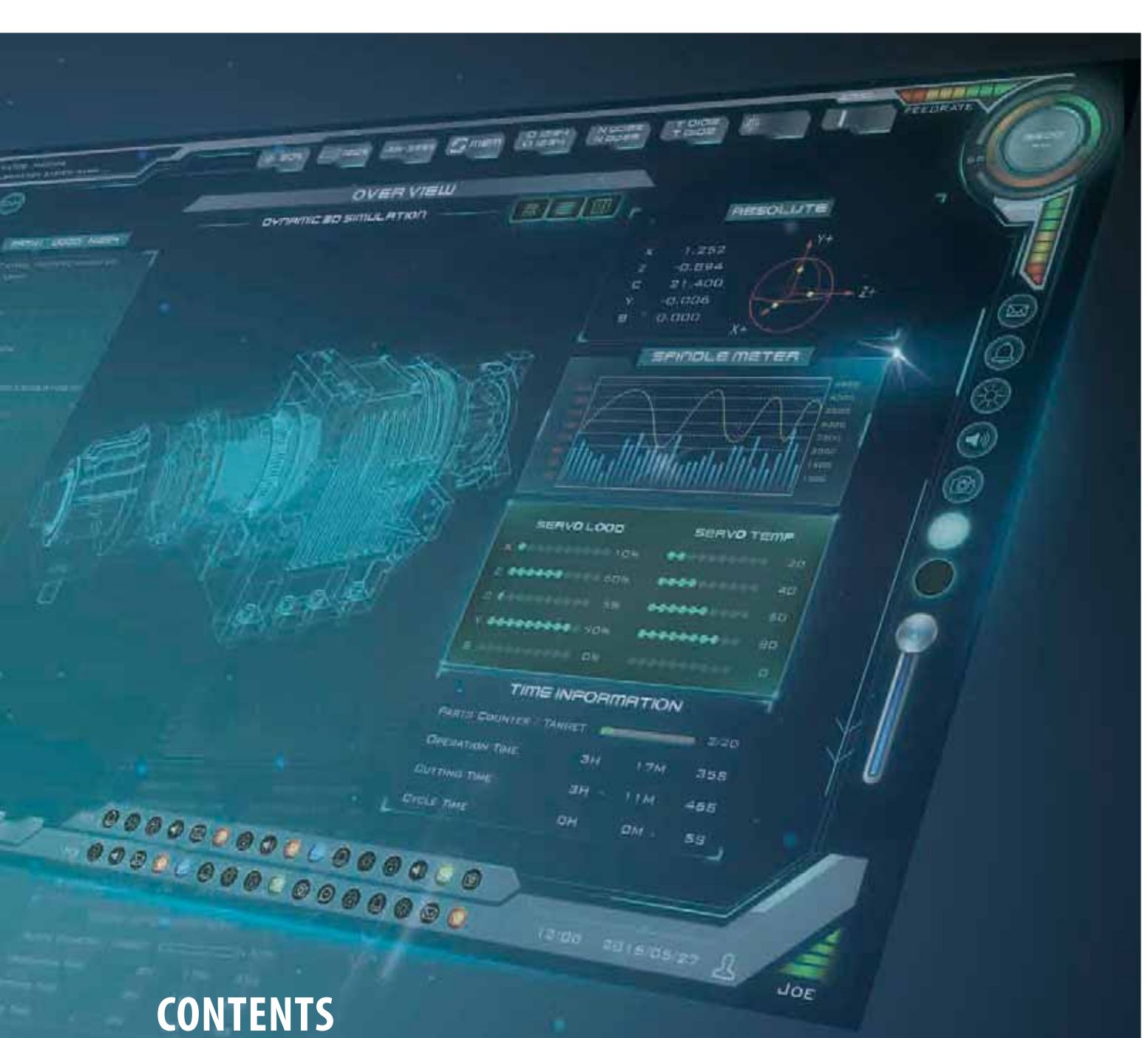

CONTENTS

03 - 04	Company Profile	37 - 38	GV-1000 series
05 - 06	Operation Center	39 - 40	GV-1 / GV-F series
07 - 12	Intelligent machining	41 - 42	SUPER GV series
13 - 16	Core Technology	43 - 44	SW series
17 - 20	Key of Manufacture	45 - 46	SD series
21 - 22	Cylindrical Grinder	47 - 48	HA series
23 - 24	Internal Grinder	49 - 50	GS-8000 / GS-6000 series
25 - 26	GMS series	51 - 52	GS-4000 series
27 - 28	GTW series	53 - 54	GS-2000 / GS-3000 series
29 - 30	GTH series	55 - 56	GA series
31 - 32	GTZ / GTS series	57 - 58	GLS-1500 / GLS-2800 series
33 - 34	GVI series	59 - 60	GA-W / GS-200 / GLS-150 / GCL-2 / TS-150 series
35 - 36	GV-500 / GV-780 series	61 - 62	The Product Line-up

Company Profile

Goodway machine corp. was established in 1975 by Chairman Edward Yang (who graduated from National Chung Hsing University, Department of Mechanical Engineering) specialized in providing contract machining service, manufacturing Bench lathes and high-speed, high-precision lathes.

In 1982, in response to market trends, Goodway started to design and manufacture CNC lathes. In 1987, the successful launch of GCL-2 series broke records in Taiwan for Goodway and sold more than 10,000 units worldwide in the last 30 years.

In recent years, Goodway Machinery has become one of the largest professional CNC machine manufacturers in Taiwan by going public and the successful expansion of global marketing channels in 45 countries. Our Multi-tasking machine, Vertical Turning Centers, Horizontal Turning Centers and Swiss Type Machines are neck to neck with other major competitors. In 2015, we acquired a team of professionals with more than 20 years' experience on grinding machine and introduced CNC Internal / cylindrical grinding machine to meet our customer's machining, milling, grinding and other needs.

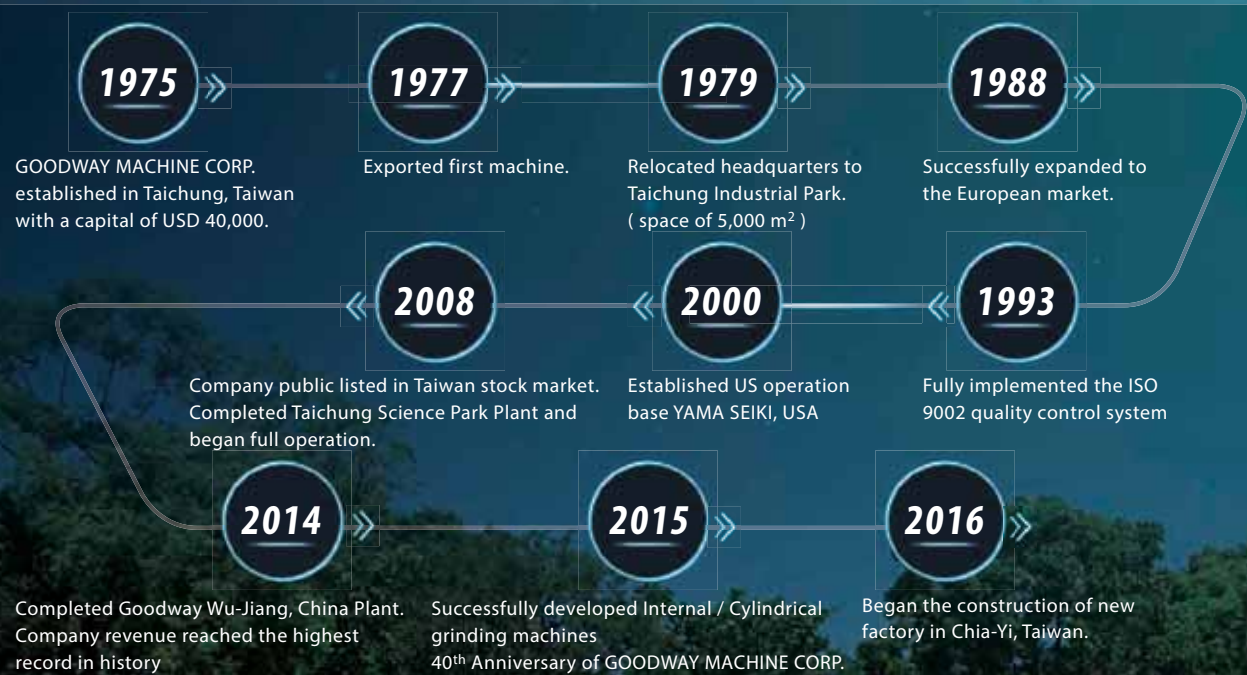

Preface

In 2015, Toyota has awarded Goodway Machinery "TOYOTA Excellent & Valuable Equipment Prizes" in recognition of Goodway's attention to technology and insistence on quality based on the outstanding quality of the Goodway machines and its contribution in improving Toyota's parts quality and production efficiency.

In 2016, the major supplier of Honda's auto parts "Aikitec" of Japan awarded Goodway Machinery "Comprehensive Award of Excellence" in recognition of Goodway's contribution in their success.

Chairman Edward Yang especially cherishes the support and recognition of the three largest auto maker of Japan. In addition this honor is a milestone not only to his individual success but also for the entire Goodway Group. He encourages all colleagues to set their goals on continuous improvement, reinvention and highest customer satisfaction.



Edward Te-Hwa Yang, President



(Goodway Group 40th Anniversary - Family Day)



Operation Centers

Global Distribution Network
Provide the best quality real-time service.

Due to long-term planning and gradually growing business needs, Goodway recently carried out a number of new operation construction plans, including large-scale new facilities in Chiayi, Taiwan and Wujiang, Jiang-Su Province. Our goal is to provide real-time service to every customer on a timely basis.

HEADQUARTERS



Location : TAICHUNG · TAIWAN
 Area : 18,600 m²
 Processing and assembly of key components

CTSP BRANCH



Location : TAICHUNG · TAIWAN
 Area : 26,600 m²
 Manufacturing of turning centers

YAMA SEIKI USA, INC.



Location : LOS ANGELES · CALIFORNIA
 Area : 20,000 m²
 Sales and service



OPERATION CENTER

- **HEADQUARTERS**
TAICHUNG · TAIWAN
- **CTSP BRANCH**
TAICHUNG · TAIWAN
- **CHIAYI BRANCH**
CHIAYI · TAIWAN
- **WUJIANG BRANCH**
SUZHOU · CHINA
- **DONGGUAN BRANCH**
DONGGUAN · CHINA
- **YAMA SEIKI USA, INC.**
LOS ANGELES · CALIFORNIA
- **HANGZHOU OFFICE**
HANGZHOU · ZHEJIANG
- **CHONGQING OFFICE**
CHONGQING
- **WUHAN OFFICE**
WUHAN · HUBEI
- **TIANJIN OFFICE**
TIANJIN
- **JINAN OFFICE**
JINAN · SHANDONG
- **FUJIAN OFFICE**
FUZHOU · FUJIAN

DEALER & SERVICE

- **EUROPE**

Sweden	Netherlands	Poland	Slovenia	Turkey
Denmark	England	Portugal	Croatian	Ukraine
Finland	Switzerland	Spain	Romania	Czech
Germany	France	Italy	Bulgaria	Russia
- **ASIA**

Japan	Philippines	India
Korea	Malaysia	Israel
Indonesia	Singapore	Pakistan
Thailand	Vietnam	
- **AMERICA**

Canada	Egypt	Australia
Brazil	South Africa	New Zealand
Argentina		
- **AFRICA**
- **OCEANIA**

MARKET DISTRIBUTION

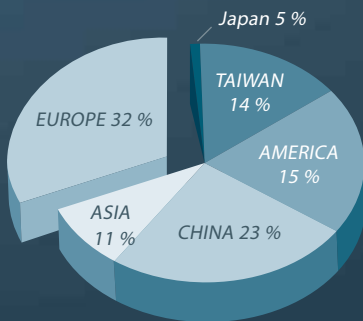

WUJIANG BRANCH



Location : SUZHOU · CHINA
 Area : 66,800 m²
 Manufacturing of turning centers

DONGGUAN BRANCH



Location : DONGGUAN · CHINA
 Area : 500 m²
 Sales and service

CHIAYI BRANCH



Location : CHIAYI · TAIWAN
 Area : 100,000 m²
 Under Construction

G.NET

Remote Monitoring

Application

Production Management



Prognosis System



Remote Assistance System



MES/ERP Integration

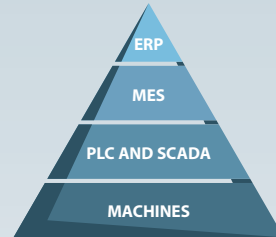

Platform

G.NET + IoT Platform

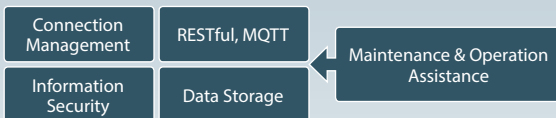

Customer exclusive virtual machine in the cloud



CaaS / VPC / VPN (Hi-Link or IPSec)

Network

Fixed Network



Mobile Network



Equipment

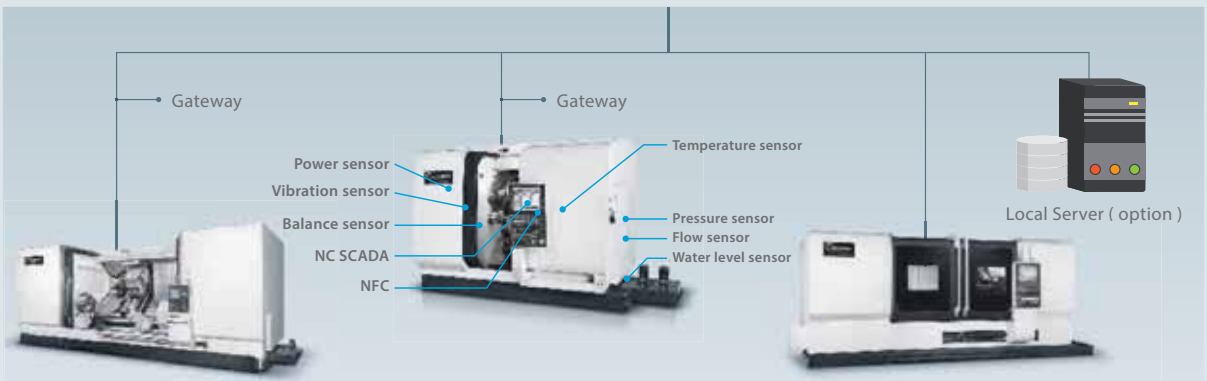



G.LINC

— Intelligent Front-End HMI System —





























The new generation of G.LINC - intelligent front-end HMI system is with faster hardware, operating systems and more powerful software. 256 GB large SSD memory meets more manufacturing needs. 21" LCD monitor with capacitive multi-touch screen for more intuitive and flexible operation.

Built-in all kinds of the latest wireless communication interface, so that data transmission is more simple and fast, but also easy to control the use of the machine to keep the machine more secure use. We have a breakthrough technology and ideas to build the G.LINC, it is ready to work with you into the next generation of intelligent manufacturing.



— Intelligent Front-End HMI System —

Each G.LINC can install a variety of practical software, with the hardware touch function to create more user experience, intuition, practical, intelligence, improve efficiency has always been our innovative principles. In each part of the manufacturing process will have a relatively smart tool to increase the use of efficiency, and then play the maximum efficiency of the machine.

<p>Programming</p> 	<p>The conversational sequential programming treats the user more friendly. Allowing the programmer focus on the manufacturing itself without spending extra effort on the memory and search of all kinds of instructions. The cutting assistant can help you selecting the cutting parameters that are more suitable for using machine in high efficiency.</p>	   
<p>Intelligence</p> 	<p>The intelligent software functions in the manufacturing process improve the production efficiency. No humanization & simplification make the use of machine easier. On line Anti-collision detection also enhances the protection, of the machine. Power monitoring and vibration analysis allows you to keep the pulse of the machine healthy and prevent occurrence of downtime.</p>	      
<p>Set Up</p> 	<p>Simple setting is always pleasing without fear, the settings of G.LINC are clearly classified and straightforward, and the setting are no longer fear and hard work.</p>	    
<p>Diagnostic Maintenance</p> 	<p>Routine machine maintenance is the cornerstone of stable manufacturing. The system will take the initiative to remind the maintenance, no more manual records. The quick diagnostic function allows you to quickly understand the machine's immediate health status.</p>	  
<p>Help</p> 	<p>The preservation and reading of manual is inconvenience. The built-in electronic manual can be fast search at any time that provides highly efficient and convenient for using machine. Multimedia video offers a direct demonstration of all kinds of operations; complement the lack of reading the text, so that the beginners get started easier.</p>	   



Goodway Programming System (GPS)

Fast start friendly programming environment.



■ The modular arrangement of the main screen, high legibility display of machining parameters.



■ Customize fixed form function.



■ Rich in all kinds of turning, milling selection.



■ Sub-spindle parts receiving program.



■ All kinds of drilling options.



■ Dialogue window input machining conditions.



■ M code accessibility selection list.



■ Cutting assistant, according to the actual model to give the most appropriate cutting parameters

Automation Systems

Goodway's experienced application engineering team can design automation equipment tailored to your production needs based on the drawing of the parts thus improving efficiency and lowering labor cost.



Variety of Automation Systems



■ Robotic arm and stocker



■ Gantry type robotic arm and stocker



■ Loading & unloading system



■ Auto. loading & unloading system and flipping device



■ Gantry type robotic arm and stocker



■ Auto. accuracy inspection

High Pressure Coolant System

In response to increasingly stringent requirements for modern manufacturing, Goodway introduced new capabilities for High-pressure coolant systems to provide you with a full range of high-speed and high precision manufacturing solutions. Whether cutting feed improvement, tool life extension, chip breaking effectiveness or other processing needs all can be accomplished.



Smart / series

High Pressure Coolant System

- ✔ Digitalized, intelligent and Human-machine integration operation mode.
- ✔ Provides integration among different systems by communication protocols
- ✔ Enhance the industrial structure and output value of the manufacturing industry

System Advantage

Machining Speed

- Cutting speeds can be increased up to 20% or more.
- Extend tool life up to 25% to 400%.
- Reduce machining cycle time up to 70%.

Machining Precision

- Improved cutting accuracy with excellent surface finishes.

Tool Life

- Excellent in deep-hole machining with best chip removal capability.
- Breakthrough the vapor barrier for tool-tip heat removal.

Chip Removal

High Pressure vs. Low Pressure Cooling Cutting Effect

Lathe Application



High-Pressure



Low-Pressure

Heat Disperse

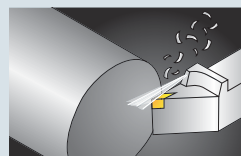

High-Pressure

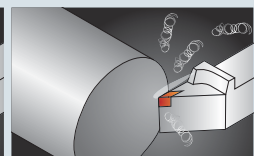

Low-Pressure

Mill Application

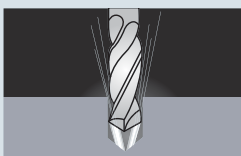

High-Pressure

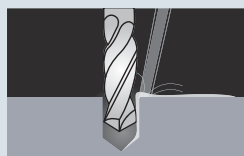

Low-Pressure

Tool Life



High-Pressure



Low-Pressure

Live Tooling Turret

Designed and developed our own live tool turrets in 2002. All live tool turrets are individually designed to optimize its function, thus all Goodway machines capabilities and performance, as well as compatible to existing tool-holders, exceed competitive offerings and are superior to the others in the same class.

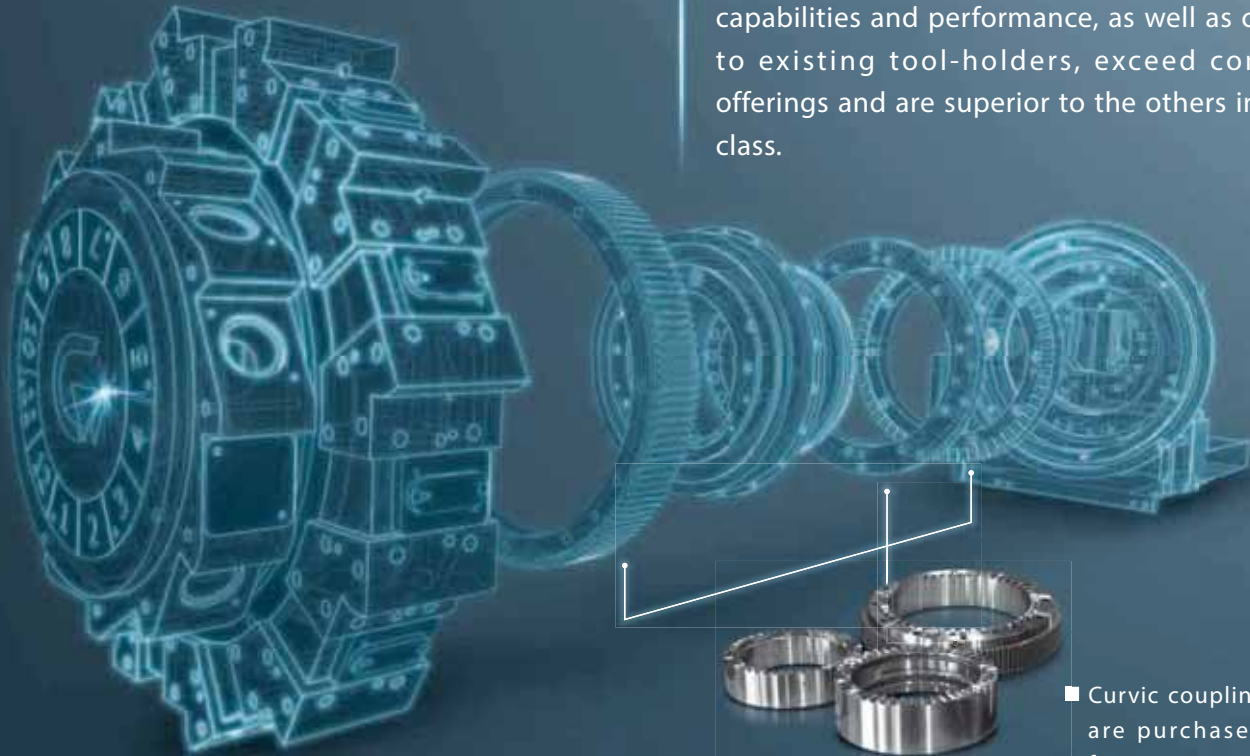

■ Curvic coupling and gears are purchased by Japan famous company.

Multi-Tasking Turning Capabilities

Compound Mechanism

Over 15 years sales of self-developed live tooling turrets which are developed for each particular models to ensure all GOODWAY machines carries the better integration, durability and performance than other competitors.



Tool spindle / Turret



Turret / Gang tooling



Twin spindles / Twin turrets



Twin spindles / Twin turrets

- Use motor for faster and more reliable tool change.
- The use of advanced live tool drive technology allows tool rotation only in the working position, which not only saves energy but protects the environment while reducing machine structural wear.



Live Tool Holder

- Goodway offers a full range of live tool holder to meet a variety special processing needs.



Multi-Function



Live Tooling Turret with C-axis



Sub-Spindle



Y-axis



B-axis

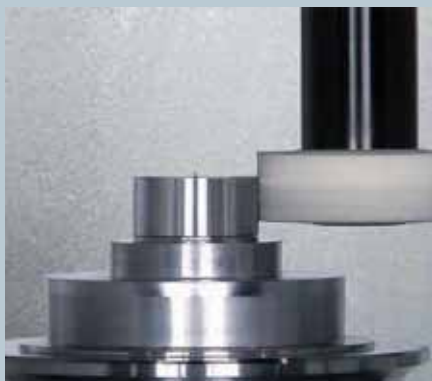

Grinding

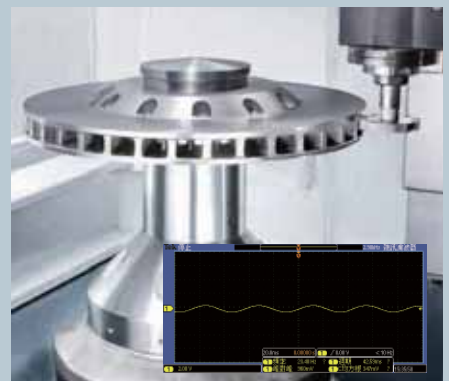

Work-Piece Dynamic Balancing Analysis

Ability to Develop Large Machine

The use of advanced FEA Finite Element Analysis in combined with 3D CAD optimized design allows large-size parts to reach maximum rigidity and strength. Goodway large machines have outstanding performance under severe cutting conditions.

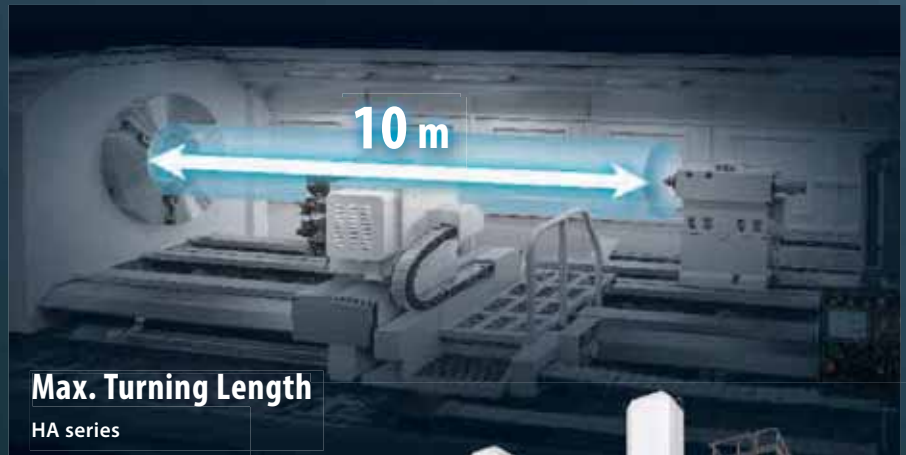
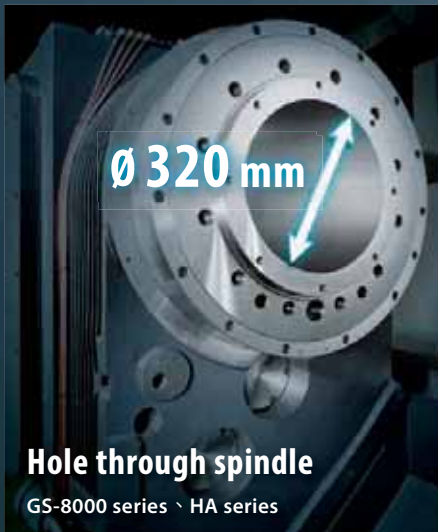
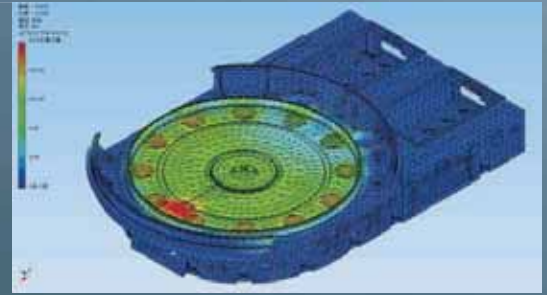

Custom Equipment Developed Capability

Focusing on high-speed and high-volume production needs, Goodway development team used a large database analysis to produce fixtures and measurement equipment tailored to your needs. Any complex parts can be manufactured from feeding the raw material to completed parts in one cycle without human interference.



Loading & unloading time

General

10 sec.

With Equipments

4 ~5 sec.

Production Rate

↑ 50%

■ Specialized Chuck



■ Trimmings Device



■ Automatic Butted Device



■ Work-Piece Determining Device



■ Work-Piece Lean Platform



■ Integrated Capability



Key Manufacturing

All main spindles, turrets, tailstocks and other core units are designed and built by Goodway in order to achieve high standard of quality as well as to ensure ultimate performance and longer life span.

R & D center

The develop team accounts for 20% of all employees and 80% of them have Master's degrees.



■ CTSP Branch R & D center



■ Intelligent Control System Lab

Assembly of core components

All core components are precisely assembled in a constant temperature controlled room, which possesses higher assembly quality and higher technology integration of machines than general competitors in the market.



■ Key components are imported from world famous companies



■ GN level precisely measuring clearance of spindle bearing



■ Spindle dynamic balancing analysis

Precision machining

Core components are precisely machined by several world class equipments in a constantly temperature controlled A/C system to achieve the strict accuracy requirements.

- 1 Japan YASDA high precision horizontal machining center
- 2 Japan MITSUI SEIKI horizontal machining center
- 3 Japan TOSHIBA bridge type 5- face machining center
- 4 U.K. TAYLOR HOBSON roundness machine
- 5 German ZEISS 3D coordinate measuring machine



Quality control

Utilizing advanced inspection equipments to implement the accuracy check to ensure the final performance and quality of machine.



■ 3D contour detection

■ Ball bar test



■ Laser detection



■ High Precision Hand Scraping

Production Capacity

We follow the ISO-9001 international quality assurance standards. Each product manufactured by Goodway is assembled by professional technicians in climate controlled modern facilities. After four decades of consistent quality control, Goodway turning centers and grinders has gradually built its high-performance and high quality brand image.



■ Flatness check for linear guide ways



■ Auto. storage system



SWISS Type turning center
production line



Horizontal turning center
production line



Vertical turning center
production line

GRU / GRA / GRW SERIES

CNC Cylindrical Grinder



GRU series

GRA series

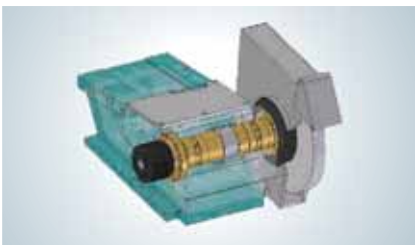

Grinding Wheel Spindle Supported by Hydro-static Bearing

The grinding wheel spindle is precision machined from Nickel Chromolybedenum alloy steel (SNCM-220). It is supported by hydro-static bearing, which greatly upgrades the spindle running stability while reducing temperature growth to a minimum.

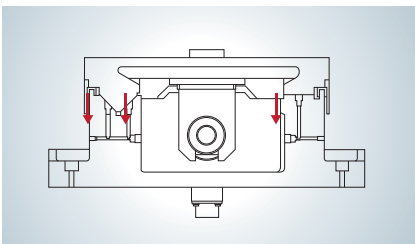

Hydro-static Lubrication on X \ Z axes Slideways

The cross and longitudinal slideways for the grinding wheel head are lubricated by a hydro-static automatic lubrication system. This outstanding lubrication system allows for extremely smooth movement of the grinding wheel head, accurate feed and ensures high grinding accuracy.



Advanced Construction Design

- X-axis with hand scraping extra large V type guide way to ensure the best dynamic accuracy and balance loading. *1
- C1 class (X-axis) / C3 class (Z-axis) hardened precision ground ball screws ensure the highest accuracy and durability possible. Plus, pretension on all axes minimizes thermal distortion.

*1 X & Z axes are all V type guide way design on GRW series.



GRW series

Grinding Examples

GRU series / Plunge Grinding

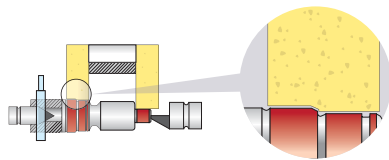

GRA series / Angular Grinding

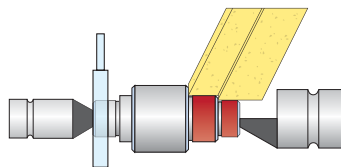

GRW series / Traveling Head Grinding

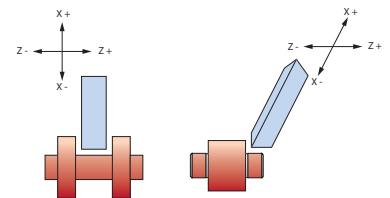

Combine Plunge and Angular Grinding in One

The specially designed GRW series from Goodway is suitable for both plunge grinding and angular grinding. It helps the customer to save investment cost, dramatically upgrade machining efficiency and create more profits.

		GRU-2040	GRU-2060	GRA-2060	GRW-4006	GRW-4010	GRW-4015	GRW-4020
Distance between centers	mm	420	620	620	630	1,030	1,530	2,030
Max. swing over table	mm		Ø 200	Ø 200			Ø 420	
Max. load between centers	kg		80	80			750	
Max. external grinding dia.	mm		Ø 190	Ø 190			Ø 400	
Roundness	μm		0.8	0.8			1.5	
Wheel spindle swivel angle			±30°	±30°			0° ~ 35°	
Wheel O.D. x width x I.D.	mm		Ø 405 x Max. 80 x Ø 127	Ø 405 x Max. 80 x Ø 127			Ø 600 x Max.100 x Ø 203	
Work table swivel angle			-3° ~ +12°	-3° ~ +12°	-3° ~ +12°		-3° ~ +8°	

Specifications are subject to change without notice.

GRC SERIES

Center Hole CNC Grinder



- High accuracy work-piece setup permits roundness error less than $1 \mu\text{m}$.
- Center hole surface roughness $N4 \sim N6 = 0.2 \sim 0.8 \mu\text{m}$.
- Grinding wheel dressing is NC controlled with dressing amount compensation function.
- Automatic centering for work-piece clamping simplifies work-piece setup.

Extra high positioning accuracy center hole achieves less than $10 \mu\text{m}$ of alignment error between center hole and axial center.

Internal taper angle error is less than 10 seconds.

Exclusive Grinding Motions

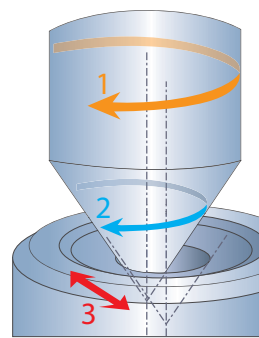

3D synchronize grinding guarantees high accuracy of center holes.

- 1 Grinding wheel rotation.
- 2 Grinding wheel spindle performs planetary motion.
- 3 Grinding wheel moves reciprocally along the conic surface.

		GRC-1000	GRC-1500
Center hole dia.	mm		$\varnothing 1 \sim \varnothing 60$
Work-piece clamping range	mm		$\varnothing 4 \sim \varnothing 220$
Work-piece length	mm	50 ~ 1,000	50 ~ 1,500
Work-piece weight	kg		120
Center hole angle			60°
Grinder wheel spindle speed	rpm		45,000

Specifications are subject to change without notice.

GRI SERIES

CNC Internal Grinder



- With 0.001 mm setting unit on the wheel head.
- Exclusively designed moving X-axis provides increased convenience of operation.
- The work head can be swiveled between $+3^{\circ} \sim -7^{\circ}$ for taper grinding.
- The work head is equipped with a sensor. It not only saves time in grinding wheel and work-piece mounting and dismounting, but also can detect spindle speed and belt breakage.
- Advanced CNC control with teach-in programming function. Machining programs are automatically generated through while increasing efficiency.

Grinding Examples

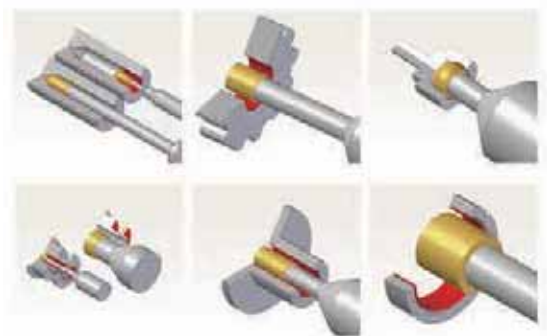

▀ X-axis slideways

		GRI-150
Inside diameter range	mm	Ø 6 ~ 150
Max. grinding depth	mm	150
Max. chucking length	mm	200
Swing over bed	mm	Ø 520
Swing over fluid guard	mm	Ø 320
Wheel head max. travel	mm	100
Spindle speed	rpm	13 ~ 800
Spindle angle		$+3^{\circ} \sim -7^{\circ}$

Specifications are subject to change without notice.

GMS SERIES

Tool Spindle Type 5-Axis Turning Centers

- 5-axis synchronous numerical control can overcome any complex and difficult machining.
- The tool spindle with B-axis provides free surface processing capability while improving machining accuracy.
- Dual spindle has the same bar capacity, and are built-in spindle motor design, fully meet the long and high precision machining needs.
- Double slant bed base structure, the center of gravity is lower than the general slant bed, and has a higher rigidity and load capacity.
- High rigidity box way and high precision linear guide way (Z₂-axis) of the compound slide design, with heavy cutting and fast moving characteristics.

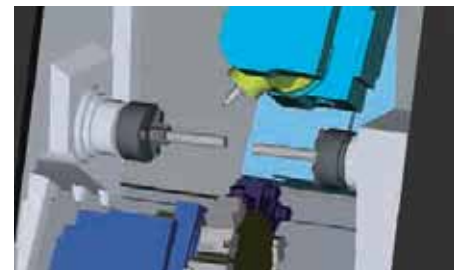
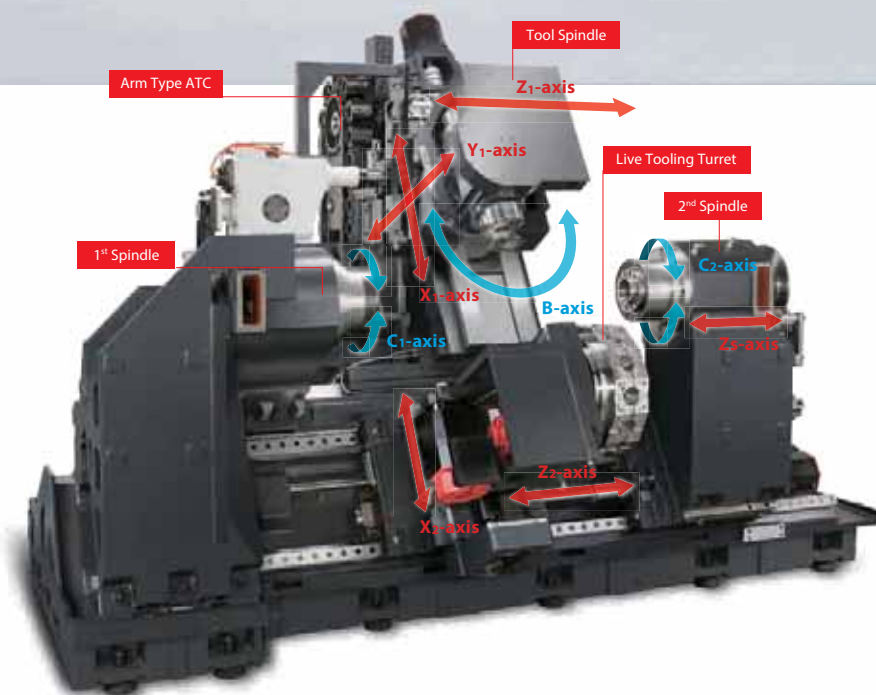

3D On-Line Interference Check

Goodway "3D online interference check", any complex programming can be pre-detected interference before actual machining. Effectively save setup time and also avoiding any crashes happening.



- 1 The tool spindle uses a three-piece curvic coupling for precision positioning, the B-axis rotation range of $\pm 120^\circ$, continuous indexing up to 0.001°
- 2 Arm type tool magazine with high-speed servo motor tool change mechanism, tool change time only 1.5 seconds. (T-T)
- 3 Live tool turret can be equipped with 15 station (ER32), adjacent tool change only 0.3 second.

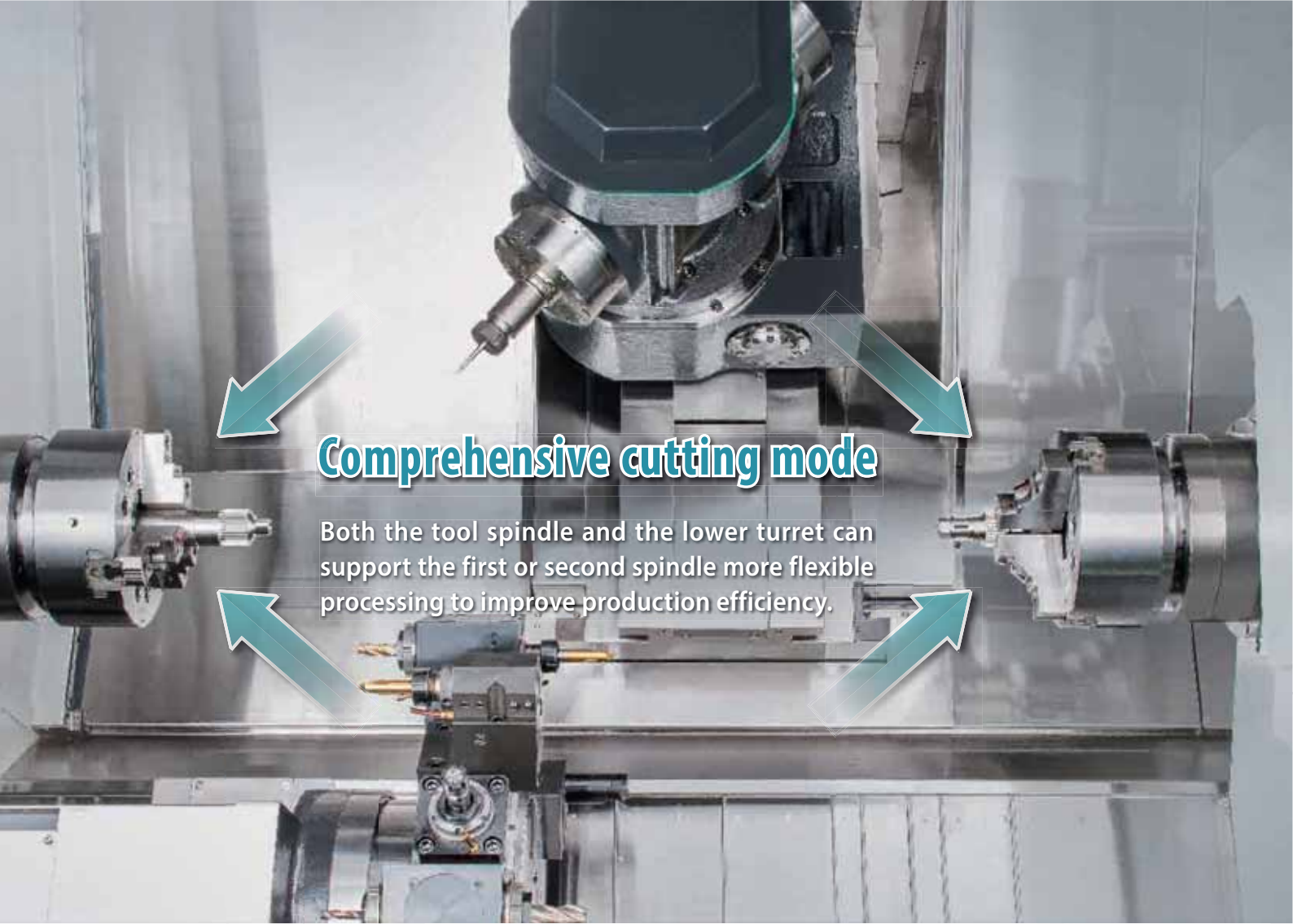

Comprehensive cutting mode

Both the tool spindle and the lower turret can support the first or second spindle more flexible processing to improve production efficiency.



GMS-2000ST

GMS-2600ST

Max. swing diameter	mm	Ø 900	
Max. turning diameter	mm	Tooling spindle : Ø 560 Turret : Ø 340	
Max. turning length	mm	Tooling spindle : 1,100 Turret : 960	Tooling spindle : 1,094 Turret : 960
Chuck size		8"	10"
Bar capacity	mm	Ø 51	Ø 65
Spindle nose		A2-6	
Spindle motor output (cont. / 30 min.)	kW	22 / 25	
Magazine / Turret capacity	T	24 (40 Opt.) / 15	
X ₁ / X ₂ axes travel	mm	600 / 185	
Z ₁ / Z ₂ axes travel	mm	1,100 / 960	
Y ₁ -axis travel	mm	160 = ±80	

Specifications are subject to change without notice.

GTW SERIES

Turret / Gang Tooling Turning Center

- A new model suitable for small and medium-sized precision parts processing, especially for medical and automotive industry.
- The back machining with 8 station gang tools design, which can effectively reduce turret interference and indexing time to improve production efficiency.
- Standard double Y-axis function, any complex front, back machining can be easily completed in one setup.
- The Z1-axis is designed with a low center of gravity 30° slant bed to provide a very stable base of the turret and also improves ease of operation.
- 3 axes design with high precision linear guideway to provide the best control and mobile efficiency.

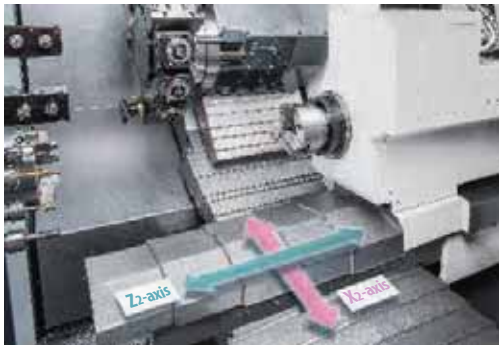

➤ Innovative design of the sub-spindle with X₂-axis, can reduce the turret interference to enlarge working range. And the sub-spindle does not need to return to home position, directly to the back machining after parts pick-up from main spindle, a substantial increase in production efficiency.

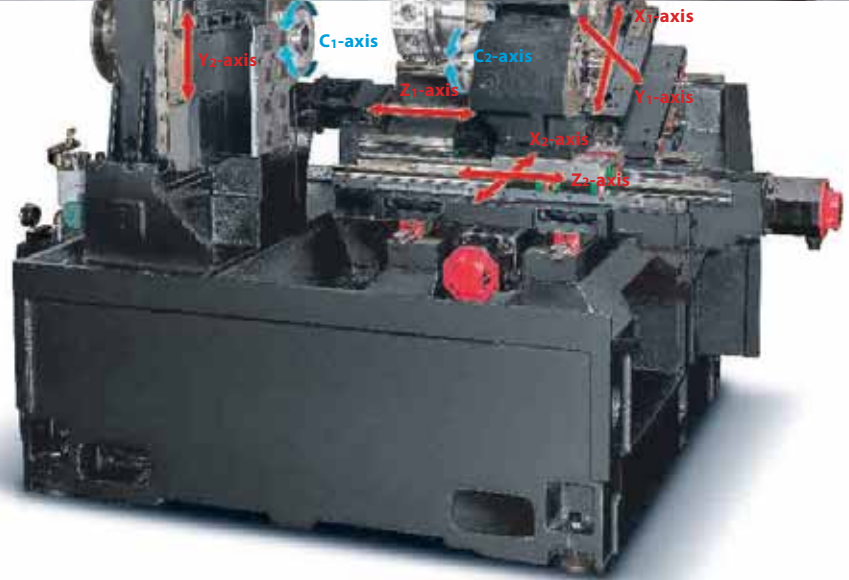

12-Station Live Tooling Turret

- Tool shank size :
□ 20 mm / Ø 25 mm
- Live tooling shank size : ER25
- Y₁-axis travel : 70 mm = ±35 mm



8-Station Gang Tooling System

- Live tooling shank size : ER20
- Y₂-axis travel : 250 mm

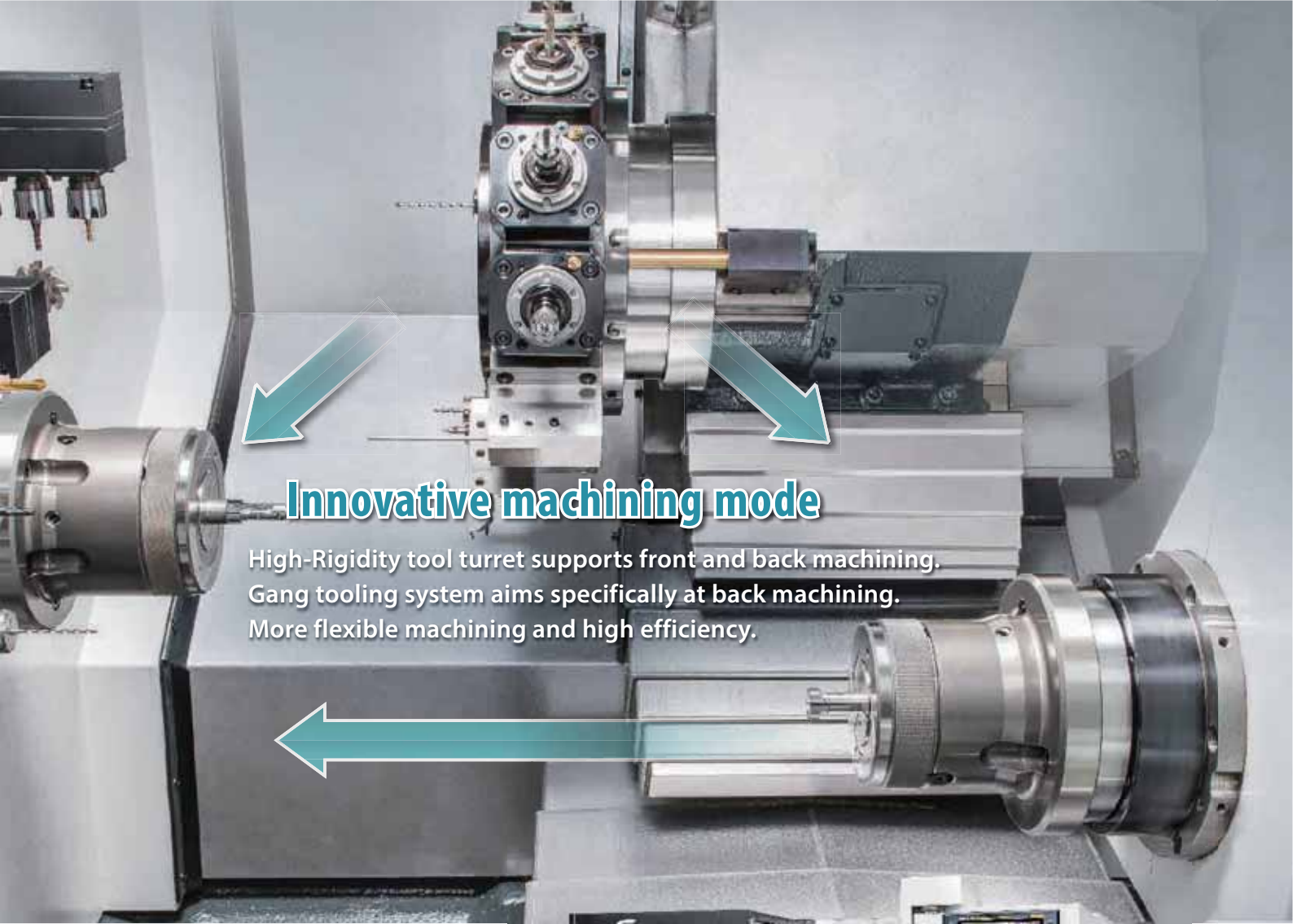

Innovative machining mode

High-Rigidity tool turret supports front and back machining.
 Gang tooling system aims specifically at back machining.
 More flexible machining and high efficiency.



GTW-1500Y

Max. turning diameter	mm	Ø 250		
Max. turning length	mm	210		
Chuck size		DIN173E	DIN177E	6"
Bar capacity	mm	Ø 51		
Spindle nose		A2-5		
Spindle motor output	kW	11 / 15 (cont. / 30 min.)		
Turret / Gang tooling stations	T	12 / 8		
X ₁ / X ₂ axes travel	mm	180 / 310		
Z ₁ / Z ₂ axes travel	mm	268 / 550		
Y ₁ / Y ₂ axes travel	mm	70 = ±35 / 250		

Specifications are subject to change without notice.

GTH SERIES

Parallel Twin Spindles Turning Centers

- Innovative parallel twin spindles construction can be easily equipped with automated equipment to meet the needs of high production. Can also be multi-machine integrated configuration to achieve maximum output efficiency.
- The twin spindles can be used for two identical operations or first and second operation with a turnaround station increasing machine utilization rate.
- Parallel twin spindles structure is conducive to the chip directly falling to the chip tank due to their own weight, and removing chips through a rear type chip conveyor.
- The full stroke of the base supports the X-axis saddle, and the X / Z axes are designed with a high rigidity box way to ensure excellent heavy cutting.

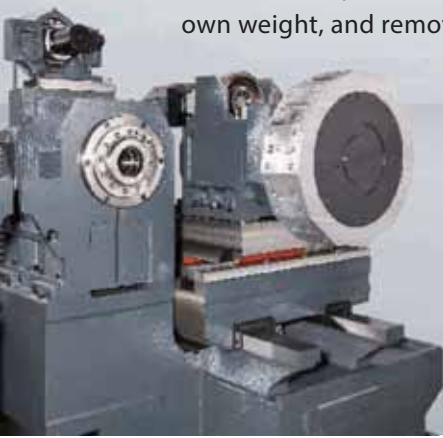

Varies Applications

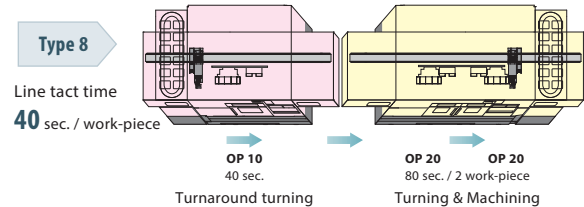
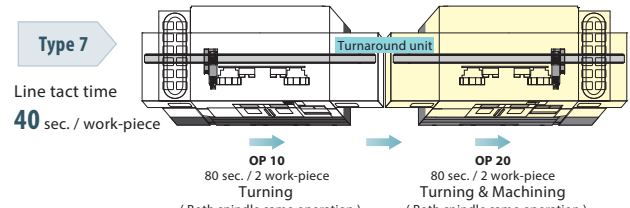
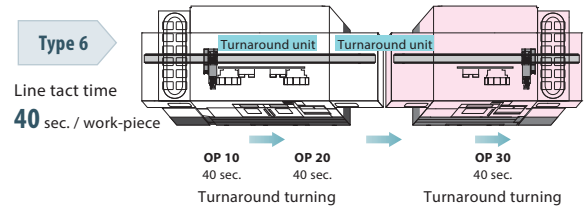
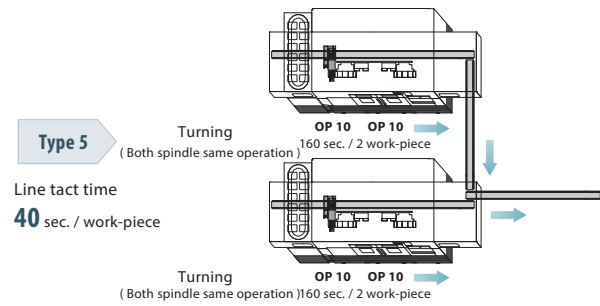
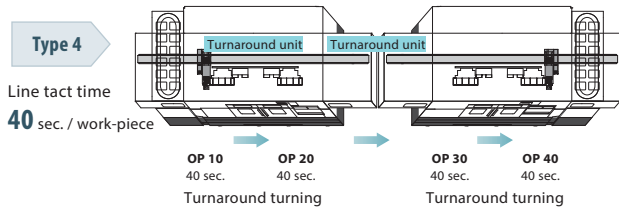
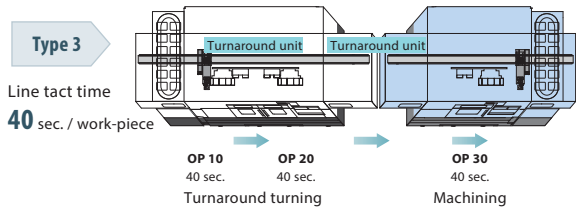
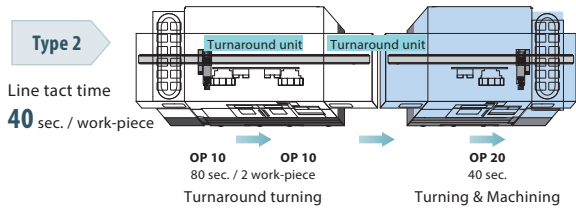
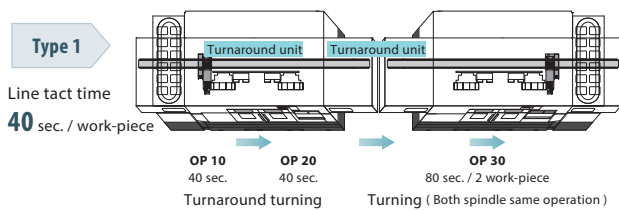



Automatic Production System

Based on the different work-piece specifications and machining characteristics, Goodway provides you with the most suitable automation system to achieve high efficiency, unmanned production.

Example as shown :
 Max. gripper clamp weight : 3 kg / Jaw
 X-axis rapids : 2,500 mm / sec



1 Work-piece engage



2 First Spindle unloading / loading



3 Flipping work-piece



4 Second spindle unloading / loading



5 Work-piece detection / unloading



GTH-2000		
Max. turning diameter	mm	Ø 300
Max. turning length	mm	205
Chuck size		10"
Hole through spindle	mm	Ø 66
Spindle nose		A2-6
Spindle motor output	kW	11 / 15 (cont. / 30 min.)
Turret station	T	12
X / Z axes travel	mm	195 / 220
X / Z axes rapid feed rate	m/min.	24

Specifications are subject to change without notice.

GTZ SERIES

Twin Spindles & Turrets Turning Centers



- The upper and lower turret can be used simultaneously or separately to support the first and second spindles enabling more flexible machining.
- The upper and lower turret can be balancing cutting in the twin spindle, greatly reducing the vibration of slim work-piece, and effectively shorten the cycle time also increased the roundness accuracy.
- High rigidity low center of gravity 45 ° slant bed with roller-type linear guideway to ensure high-speed, high-precision performance.
- Optional 12 / 16 station live tool turret and Y-axis.

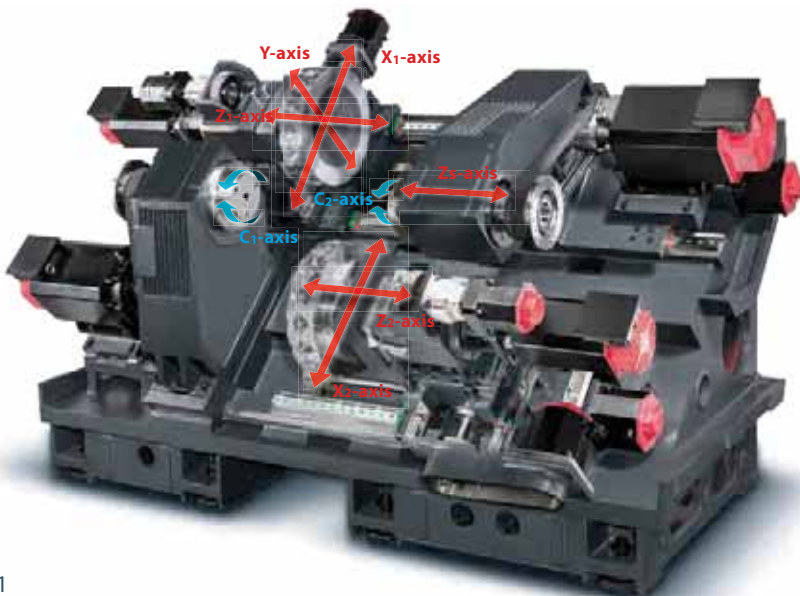

		GTZ-2000	GTZ-2600
Max. swing dia.	mm		Ø 270
Max. turning dia.	mm		Ø 250
Max. turning length	mm	604 (615) ^{*1}	592 (603) ^{*1}
Chuck size		6" (Big-bore)	8" (Big-bore)
Bar capacity	mm	Ø 51	Ø 65
Spindle nose		A2-5	A2-6
Spindle motor output	kW	11 / 15 (cont. / 30 min.)	
Turret / Live tooling Turret stations	T	12 + 12 (Opt. 16 + 16)	
X1 / X2 axes travel	mm	195 / 210	
Z1 / Z2 axes travel	mm	620 / 620	
Y-axis travel	mm	100 = ±50	

^{*1} 16 turret station Specifications are subject to change without notice.

GTS SERIES

Twin Spindles & Turrets Turning Centers



- Twin turrets supports first and second spindle respectively, machining efficiency is equivalent to two turning centers in one.
- Both end of long bar being clamped by twin spindles synchronization without falling due to weight enhancing machining precision.
- Low center of gravity 45° slant bed with high speed linear guideway (GTS-150) or high rigidity box way (GTS-200) to meet a variety of machining needs.
- 12 station servo turret, optional 12 station live turret and twin Y-axis function.

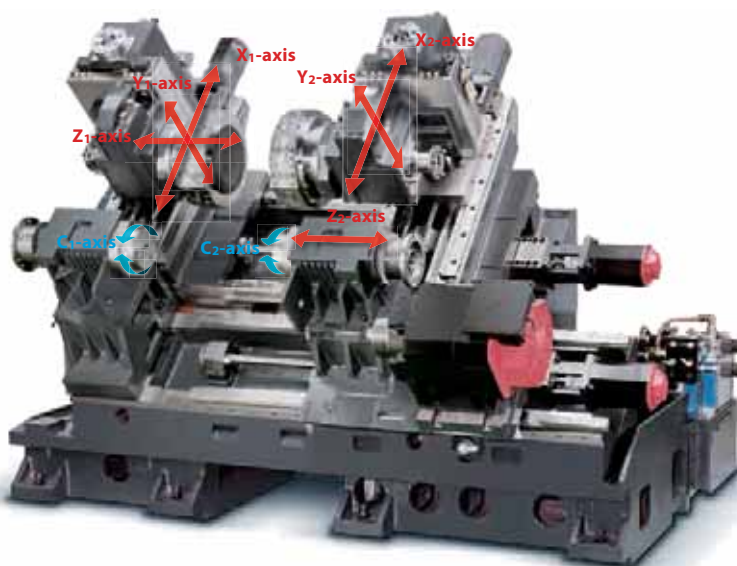

		GTS-150	GTS-200 / 260
Max. swing diameter	mm	Ø 180	Ø 280
Max. turning diameter	mm	Ø 180	Ø 280
Max. turning length	mm	180	200
Chuck size		6"	8" / 10"
Bar capacity	mm	Ø 42	Ø 51 / 65
Spindle nose		A2-5	A2-6 / A2-8
Spindle motor output (cont. / 30 min.)	kW	5.5 / 7.5	11 / 15
Turret / Live tooling turret stations T		12	12
X1 / X2 axes travel	mm	155 (160) ^{*1}	190 (220) ^{*1}
Z1 / Z2 axes travel	mm	180 / 500 (210 / 600) ^{*1}	270 / 740
Y1 / Y2 axes travel	mm	±30	±60

*1 Y-axis model

Specifications are subject to change without notice.

GVI SERIES

Inverted Vertical Combination CNC Turning Center

- Twin spindles and twin turrets help finish the front and rear machining of the work-piece in one set-up saving operating manpower.
- Inverted first spindle takes up work-piece from auto-loading conveyor while enabling second spindle to receive work-piece, enhancing production efficiency.
- Inverted spindle helps chips to fall in chip conveyor due to its own weight, removing chip remains and ensuring machining precision.
- Compact design helps reduce machine foot-print up to 15% comparing to traditional vertical twin spindle turret machine.
- The machine is equipped with a servo 8 station turret, live tool turret and C-axis are available for option.

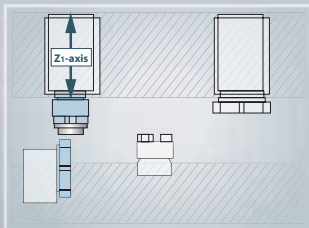

Lower turret can cutting on 1st spindle

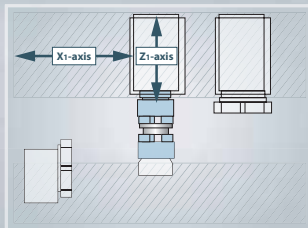

Both spindles can be programmed for synchronized parts catching.

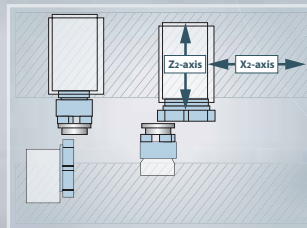

Dual system can be programmed for synchronized turning.



GVI-350

Max. swing diameter	mm	Ø 550
Max. turning diameter	mm	Ø 350
Max. turning height	mm	400
Chuck size		12"
Spindle nose		A2-8
Spindle motor output (cont. / 30 min.)	kW	11 / 15
X ₁ / Z ₁ axes travel	mm	750 / 550
X ₂ / Z ₂ axes travel	mm	550 / 550

Specifications are subject to change without notice.



Automatic Production System

Combining automatic loading and unloading system, work-piece rotation station, and high speed tapping centers, Goodway provides the most efficient brake disk automatic production system in the market (offering solutions for different machining purposes)



1 Automatic feeding



2 Synchronization on twin spindle



3 Automatic discharge



4 Work-piece flipping



5 High speed drilling and tapping

Intelligent Production System

In response to the revolution of "Industrial 4.0", GVI automatic production system also combines innovative skills such as Goodway's G.NET remote monitoring, online work-piece dynamic balancing, 3D detector, robotic arm and more. Achieving the intelligent production goal of unmanned manufacturing factory and small-volume large-variety productivity.



▶ FANUC 3D Area Sensor



▶ Robot Arm



▶ Auto. accuracy inspection

GV-500 SERIES

Vertical Turning Centers



- Compact structure combined with rear-exit chip conveyor. Cover area 3.3 m², allowing more space for factory arrangement.
- 8 or 12 station servo turret, optional 12 live tool turret and C-axis as turning centers are also available.
- Column and base designed as one piece with hand scraping at contact surface, ensuring structure rigidity and load distribution.
- X / Z axes use high-precision linear guide way, providing high speed and precision.



Twin Spindles & Twin Turrets GV-500X Series

Twin spindles and twin turrets are designed with the same specification, combined with automatic loading and unloading system and work-piece rotating function. Work-piece can be completed in one set-up.

		GV-500
Max. swing diameter	mm	Ø 650
Max. turning diameter	mm	Ø 620
Max. turning height	mm	520
Chuck size		12" / 15" (Opt.)
Spindle nose		A2-8
Spindle motor output (cont. / 30 min.)	kW	15 / 18.5
X / Z axes travel	mm	350 / 550
X / Z axes rapid feed rate	m/min.	24

Specifications are subject to change without notice.

GV-780 SERIES

Vertical Turning Centers



- 8 or 12 station servo turret, optional 12 tool live turret and C-axis as turning centers are also available.
- Column and base designed as one piece with hand scraping at contact surface, ensuring structure rigidity and load distribution.
- X / Z axes uses roller type linear guide way, providing high speed and rigidity.
- The selection of dual-face turning holders enables finishing on both sides of the work-piece simultaneously, increasing machining efficiency 50% more than standard tools.



WBA displayed in G.LINC 350 (opt.)

Work-piece Balancing Analyzer (WBA)

Applied on "unbalancing detecting of unsymmetrical work-piece" and "dynamic balancing analysis after machining" Removing uneven parts by live tooling turret helps complete dynamic balancing of work-piece.

		GV-780
Max. swing diameter	mm	Ø 850
Max. turning diameter	mm	Ø 820
Max. turning height	mm	660
Chuck size		15" / 18" (Opt.)
Spindle nose		A2-11
Spindle motor output (cont. / 30 min.)	kW	18.5 / 22
X / Z axes travel	mm	500 / 670
X / Z axes rapid feed rate	m/min.	24

Specifications are subject to change without notice.

GV-1000 SERIES

Vertical Turning Centers

- The base and column are made with MEEHANITE grade casting combined with good thermal equilibrium in order to fulfill the need of long hours machining.
- Turret disk indexed precisely by \varnothing 320 mm diameter curvic, ensuring turret rigidity in all conditions.
- X / Z axes direct driven by servo motors. Rapid feed rate can reach 24/ 20 m/min.
- The height from spindle nose to floor is 1,080 mm, and the distance from spindle center line to operator door is 671 mm, creating an operation-friendly environment.
- Rear-exit type chip conveyor contributes to flexible production line configuration and centralized chip processing.
- Coolant tank allows easy maintenance and 300L large capacity provides the best cooling affect.



- ✔ 2-step gear box is driven by 30 kW spindle motor, torque output can reach 3,135 N-m.



- ✔ X-axis uses high-durability roller type linear way design, providing high speed and rigidity for heavy cutting.



- ✔ Z-axis is designed with wide span and high rigidity box way, enhancing heavy cutting function and ensuring cutting stability.

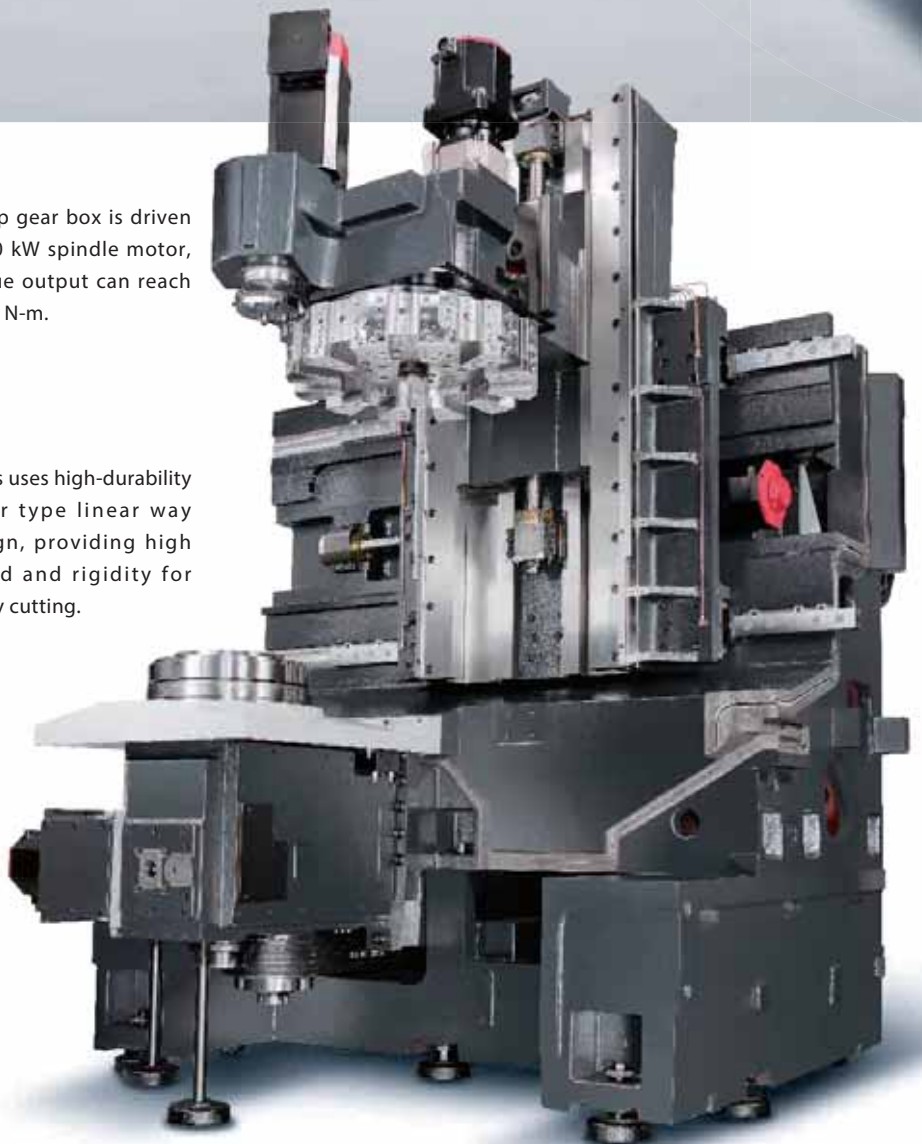



Cf-axis

Adopt Cf-axis with disk brake system can provide the strongest rigidity of C-axis function



Live tooling turret

Optional ER 50 12-station live tooling turret only spins when working, which can save energy and prevent damaged of mechanical device.



GV-1000/ATC

Milling spindle and 12 tool magazine for replacing live turret is optional for this series, fulfilling different kinds machining.

		GV-1000	GV-1000/ATC
Max. swing diameter	mm		Ø 1,020
Max. turning diameter	mm		Ø 1,000
Max. turning height	mm	760	700
Chuck size			18" ~ 32"
Spindle nose			A2-15
Spindle motor output (cont. / 30 min.)	kW		22 / 30
X / Z axes travel	mm	525 / 765	750 / 850
X / Z axes rapid feed rate	m/min.		24 / 20

Specifications are subject to change without notice.

GV-1 SERIES

Vertical Turning Centers



23,900 N·m

Workpiece spindle torque

2,400 RPM

Tool spindle speed range

12/16/24^T

ATC magazine

Side-exit

Chip conveyor

(GV-1600)

W-axis moving structure helps shorten ram structure overhang and the length between machining point to head, ensuring excellent cutting rigidity, fulfilling the need for flat and slim work-piece machining.

- W-axis has 800 mm travel with high rigidity square box way, suitable for heavy cutting.
- Cross beam is positioned by two live locking bolts and clamped with four hydraulic cylinders to ensure stable support.

		GV-1100	GV-1200	GV-1600	GV-2000
Table diameter	mm	Ø 1,100	Ø 1,250	Ø 1,600	Ø 2,000
Max. swing dia.	mm	Ø 1,400	Ø 1,600	Ø 2,000	Ø 2,050
Max. turning diameter	mm	Ø 1,200	Ø 1,350	Ø 1,800	Ø 2,000
Max. turning height	mm	1,000		1,300	
Table load capacity	kg	4,000	5,000	8,000	5,000 / 8,000
Motor output (cont. / 30 min.)	Work-piece spindle kW	37 / 45			
	Live tooling spindle kW	7.5 / 11		11 / 15	
X / Z axes travel	mm	1,300 / 900	1,375 / 900	1,600 / 900	1,700 / 900
W-axis travel	mm	600		800	

Specifications are subject to change without notice.

GVF SERIES

Vertical Turning Centers



23,900 N·m

Workpiece spindle torque

(GVF-1618)

2,400 RPM

Tool spindle speed range

12/16/24^T

ATC magazine

Side-exit

Chip conveyor

Fixed beam design: Cross beam and column are made with MEEHANITE casting and designed as one-piece, ensuring excellent vibration suppressing and heavy duty cutting ability.

- Cross beam and column are combined with strengthened rib cast structure, eliminating head overhang problems and enhancing rigidity.
- The square ram on the tooling spindle is used high rigidity closed-type design.

		GVF-1112	GVF-1214	GVF-1215	GVF-1618	GVF-2023
Table diameter	mm	Ø 1,100	Ø 1,250	Ø 1,250	Ø 1,600	Ø 2,000
Max. swing dia.	mm	Ø 1,400	Ø 1,450	Ø 1,600	Ø 2,000	Ø 2,350
Max. turning diameter	mm	Ø 1,200	Ø 1,400	Ø 1,500	Ø 1,800	Ø 2,300
Max. turning height	mm	900				
Table load capacity	kg	4,000	3,700	5,000	8,000	5,000 / 8,000
Motor output (cont. / 30 min.)	Work-piece spindle	37 / 45				
	Live tooling spindle	7.5 / 11		11 / 15		
X-axis travel	mm	1,450	1,550	1,550	1,750	2,000
W-axis travel	mm	900				

Specifications are subject to change without notice.

SUPER GV SERIES

Vertical Turning Centers

- Large machining range: Turning diameter can reach up to $\varnothing 9,000$ mm, and turning height up to 5,000 mm*1
- W-axis moving structure : X / Z / W axes all adopt high rigidity square box way, fulfilling the need for heavy cutting.
- Tool spindle adopts large size ram design, optional dual ram design is also available to support different and more flexible machining modes.
- Work-piece spindle are paired with cross roller bearings or hydrostatic bearing according to model size. Maximum work-piece weight can reach up to 300,000 kg*1
- 16 T or 24 T carousel type magazine changes tool by servo motor which provides bi-directional tool indexing, low-noise, and precise positioning.
- Optional live tooling spindle, providing compound functions such as turning, milling, and grinding.

*1 Varies according different models, shown as specification table



One-piece Column structure
(GV-2000 ~ GV-2500)

The one-piece column & bridge is firmly mounted on top of the bed, which ensures machine overall rigidity and minimizes spindle overhang to provide optimal machining accuracy.

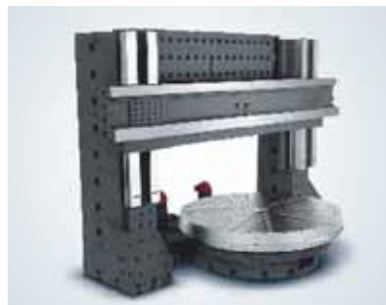

Bridge Type Structure
(GV-3000 ~ GV-8000)

The super rigid construction of the base, columns and cross beam can easily full heavy load and cutting requirements.



		GV-2000	GV-2500	GV-3000	GV-3500
Table diameter	mm	$\varnothing 2,000$	$\varnothing 2,500$	$\varnothing 3,000$	$\varnothing 3,500$
Max. turning diameter	mm	$\varnothing 2,300$	$\varnothing 2,800$	$\varnothing 3,500$	$\varnothing 4,000$
Max. work-piece weight	kg	10,000	15,000	20,000 / 45,000	
Motor output (cont. / 30 min.)	Work-piece spindle	60 / 75		(40 / 66) x 2 , Opt. (60 / 84) x 2	
	Live tooling spindle*1	11 / 15		15 / 18	
X-axis travel	mm	2,830	3,080	3,950	4,450
Z-axis travel	mm	1,200 / 1,500		1,500 / 1,800	
W-axis travel	mm	1,200 / 1,600		1,200 / 2,000 / 2,800	

*1 Opt.



1 W-axis is controlled by Goodway's twin servo simultaneous control technology and is clamped by hydraulic cylinder after being positioned by two live locking pins, ensuring high rigidity of both cross beam and column.

2 Work-piece spindle uses hydrostatic bearing which drives rotary table easily without needing high torque output. Maintaining great dynamic accuracy even when reaching max load (GV-5000~GV-8000).

3 Cs-axis is driven by twin spindle motors that eliminates gear backlash and provides double torque output. Repeatability can reach up to $\pm 5''$ (GV-5000~GV-8000).

		GV-4000	GV-4500	GV-5000	GV-6000	GV-7000	GV-8000
Table diameter	mm	Ø 4,000	Ø 4,500	Ø 5,000	Ø 6,000	Ø 7,000	Ø 8,000
Max. turning diameter	mm	Ø 4,500	Ø 5,000	Ø 6,000	Ø 7,000	Ø 8,500	Ø 9,000
Max. work-piece weight	kg	30,000 / 60,000		100,000	150,000	250,000	300,000
Motor output (cont./30 min.)	Work-piece spindle	kW (40 / 66) x 2 , Opt. (60 / 84) x 2		(60 / 84) x 2 , Opt. (100 / 140) x 2			
	Live tooling spindle*1	kW		22 / 26			
X-axis travel	mm	4,950	5,450	6,435	7,435	8,635	9,735
Z-axis travel	mm	1,500 / 1,800		1,600 / 2,000		1,600 / 2,000 / 2,500	
W-axis travel	mm	1,200 / 2,000 / 2,800		1,600 / 2,400 / 3,200		1,600 / 2,400 / 3,200 / 4,000	

*1 Opt.

Specifications are subject to change without notice.

SW SERIES

SWISS Turning Centers

- Max. machining diameter $\varnothing 20 \sim \varnothing 42$ mm, both sub and main spindle have same machining abilities.*1
- Compound bush design, bush or bushless mode can be selected according to different machining.
- Work-piece is clamped by hydraulic cylinder which provides sufficient clamping strength and quick
- Complete tooling system enables front, cross, and back cutting and milling in one process.*1
- Sub-spindle can be equipped with independent U-Drill device, providing deep hole drilling occupying any tool station.

*1 Sub-spindle as optional

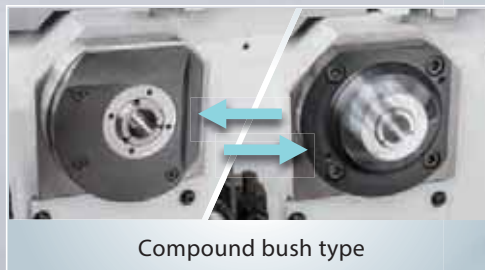

Flexible Tooling System

Tooling System		SW-20 / 32	SW-42	
A	O.D. tool	6	5	6
B	I.D. tool	4	5	5
		4	5	5
C	Live tool*1	5 (max.)	4	5
		5 (max.)	5	5

Backworking Tooling System

D	I.D. tool	4 (total)
	Live tool	



*1 The upper 3 positions are a fixed unit for cross milling and drilling, the bottom 2 positions can be increased up to front-end x5 and rear-end x2 live tools.



- 1 Standard** Cross live tool 5

- 2 Expansion** Front-end Live tool 4
Cross live tool 3

- 3 Expansion** Front-end Live tool 3
Cross live tool 5
Rear-end Live tool 2

(For SW-20 / SW-32 only)



Deep Hole Drilling (for SW-32 only)

- Sub-spindle applied 2 U-Drill devices which can offer deep hole drilling requirement but additional tool position is no needed.
- With high pressure coolant system, it can ensure the best deep hole drill performance.

- Tool diameter : Ø 1.32 mm
- Tool length : 150 mm
- High-pressure coolant system : 140 Bar
- Material : SUS303



			SW-20	SW-32	SW-42	
Working range	Max. machining diameter	mm	Ø 20	Ø 32	Ø 42	
	Max. turning length per chuck	Bush	mm	220	315	180
		Bushless	mm	50	80	110
	Rear-end max. length for front ejection	mm	80	130	110	
Max. speed	Main spindle	rpm	10,000	7,000	6,000	
	Sub-spindle	rpm	8,000	7,000	6,000	
Number of tools	O.D. tool	T	6	6	5 / 6 (Opt.)	
	I.D. tool	T	4	4	5	
	Cross live tools	T	5 ~ 10	5 ~ 10	4 ~ 10	
	Rear-end tools	T	4	4	4	
Shank size	O.D. tool	mm	□ 12	□ 16	□ 20 / □ 16 (Opt.)	
	I.D. tool	mm	Ø 10	Ø 13	Ø 13	

Specifications are subject to change without notice.

SD SERIES

SWISS Turning Centers

- Max. machining diameter $\varnothing 16 \sim \varnothing 20$ mm, max. chuck machining length 175 mm.
- Designed with pneumatic system which is environmentally friendly, safe, and easy to maintain.
- High performance bush adaptation ensures long bar machining precision.
- Sub-spindle automatic loading and unloading system, work-piece can be finished in one set-up which saves manpower cost.



Flexible Tooling System

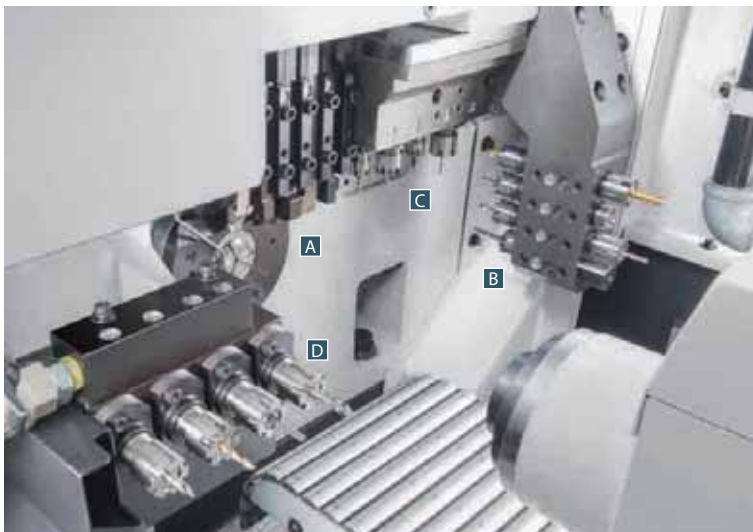

Tooling System		SD-16		SD-20
A	O.D. tool	6	5	6
B	I.D. tool	Front-end		4
		Rear-end		4 (max.)
C	Live tool	Cross	2	3
				4

Backworking Tooling System

D	I.D. tool	Rear-end	4 (total)
----------	-----------	----------	-------------

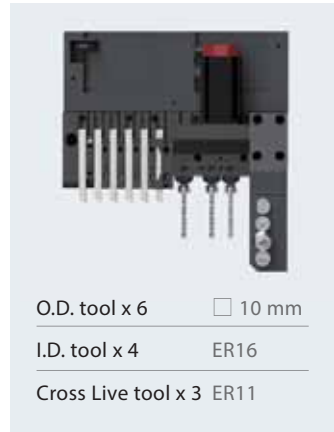

		SD-16		SD-20	
Working range	Max. machining diameter	mm	Ø 16	Ø 20	
	Max. turning length per chuck	Bush mm	175	175	
	Rear-end max. length for front ejection	mm	80	80	
Max. speed	Main spindle	rpm	10,000	10,000	
	Sub-spindle	rpm	8,000	10,000	
Number of tools	O.D. tool	T	6 / 5 (Opt.)	6	
	I.D. tool	T	4	4	
	Cross live tools	T	2 / 3 (Opt.)	4	
	Rear-end tools	T	4	4	
Shank size	O.D. tool	mm	□ 12	□ 12	
	I.D. tool	mm	Ø 10	Ø 10	

Specifications are subject to change without notice.

HA SERIES

Flat-bed Turning Centers

- One-piece wide span four box ways casting body, providing the solid base for heavy cutting.
- 45 kW high power spindle motor driven by 3-step gear box, torque can reach up to 13,270 N-m.
- Turret is positioned by \varnothing 450 mm curvic coupling, combined with 12,000 kg clamping ability, remains sufficient turret rigidity under any cutting condition.
- Standard side-exit chip conveyor, ensuring excellent chip removing ability.

\varnothing 1,700 mm

Max. turning dia.

10,000 mm

Max. turning length

15,000 kg

Max. work-piece weight

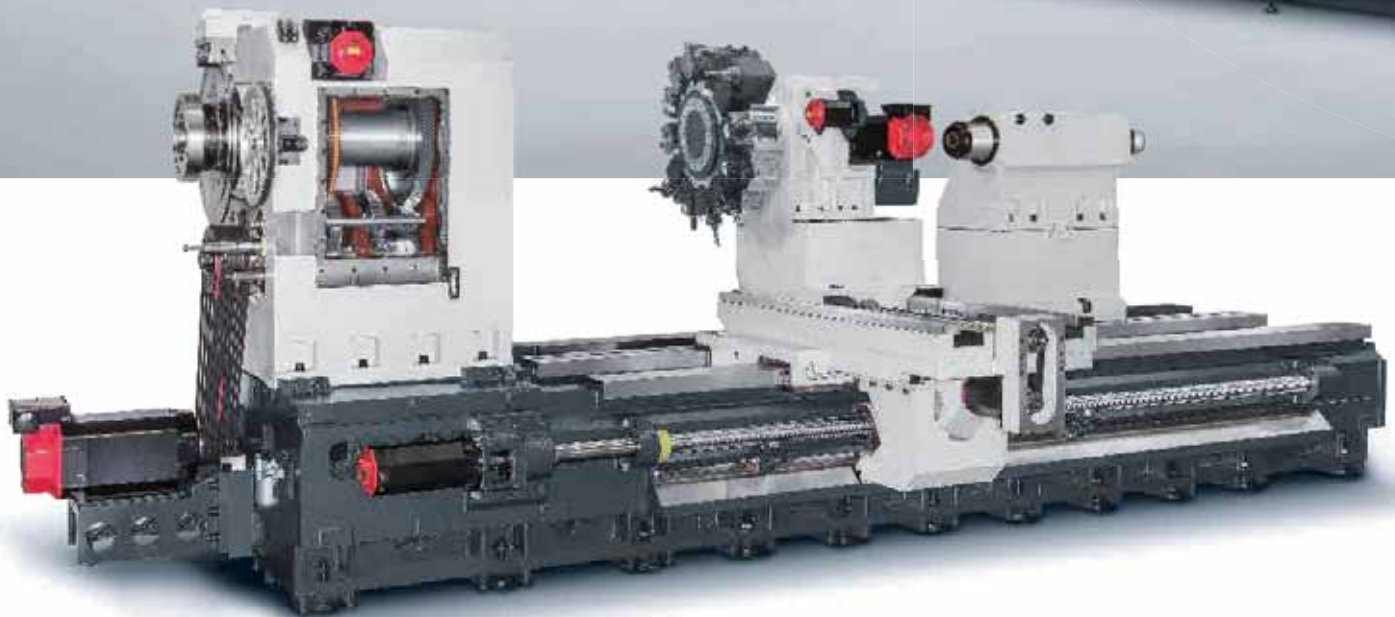

- 1 Separated rails of saddle and tailstock design on X-axis allows tailstock no need to cross saddle to support work-piece, which ensure the rigidity of tailstock.
- 2 \varnothing 200 mm (Opt. \varnothing 250 mm) high rigidity tailstock with rotary quill featuring MT#6 steady thimble and ample hydraulic thrust to provide firmly support for work-piece.
- 3 Square turret can fulfill extremely heavy turning or deep drilling machining needs. (Opt.)
- 4 Optional \varnothing 180 mm high rigidity vibrate resistant drilling tool holder allows excellent drilling ability.



Heavy-Duty Steady Rest

When the work-piece diameter is not more than $\varnothing 600$ mm, the saddle and steady rest will not interfere each other during the progress. Thus the operator does not need to stop the machine to remove the steady rest, which greatly increases working efficiency.



(Hydraulic) $\varnothing 125 \sim 460$ mm*1



(Manual) $\varnothing 300 \sim 600$ mm*1



(Manual) $\varnothing 500 \sim 800$ mm



(Manual) $\varnothing 800 \sim 1,000$ mm

*1 The steady rest does not need to be removed during the working progress.

		HA-1400	HA-1600	HA-2000
Max. swing diameter	mm	$\varnothing 1,400$	$\varnothing 1,600$	$\varnothing 2,000$
Max. turning diameter	mm	$\varnothing 1,100$	$\varnothing 1,300$	$\varnothing 1,700$
Max. turning length	mm	2,000 / 3,000 / 4,000 / 5,000 / 6,000 / 7,000 / 8,000 / 9,000 / 10,000 *1		
Max. work-piece weight	kg	10,000 ~ 15,000 (Need to be supported by steady rest)		
Flat bed width	mm	1,350		
Spindle motor output (cont. / 30 min.)	kW	37 / 45		
Turret / Live tooling turret station	T	8 or 12 / 12		
X-axis travel	mm	595	695	895
Z-axis travel	mm	2,150 / 3,150 / 4,150 / 5,150 / 6,150 / 7,150 / 8,150 / 9,150 / 10,150		
Tailstock base travel	mm	2,150 / 3,150 / 4,150 / 5,150 / 6,150 / 7,150 / 8,150 / 9,150 / 10,150		

Specifications are subject to change without notice.

GS-8000 SERIES

Horizontal Turning Centers



- MEEHANITE casting body combines 30° saddle provides solid foundation for spindle head, turret, and tailstock.
- X/Y/Z axes adopt high rigidity box ways, ensuring the best rigidity and precision with its wide span structure.
- 45 kW high power spindle motor driven by 3-step gear box, torque can reach up to 7,330 N-m.
- Ø 750 mm large size turret disk is indexed by Ø 450 mm curvic couplings, providing strong cutting ability.
- Ø 160 mm rotary quill's tailstock combines sufficient hydraulic thrust provides stable support for work-piece.
- Y-axis 320 mm travel range holds leading position in industry and is able to overcome any difficult machining mission easily. (opt.)

		GS-8000	GS-8600	GS-8800
Max. swing diameter	mm		Ø 1,030	
Max. turning diameter	mm		Ø 970	
Max. turning length	mm	1,200 / 2,200 / 3,200 / 4,200 / 5,200 / 6,200		
Chuck size		18" (Opt. 24")		
Bar capacity	mm	Ø 205	Ø 260	Ø 320
Spindle nose		A2-15	A2-15	A2-20
Spindle motor output (cont. / 15 min.)	kW	30 / 45		
X / Y axes travel	mm	525 (Y-axis model : 515) / 320 = ±160		
Z-axis travel	mm	1,200 / 2,200 / 3,200 / 4,200 / 5,200 / 6,200		

Specifications are subject to change without notice.

GS-6000 SERIES

Horizontal Turning Centers



- 45° low center gravity slant bed ensures high rigidity of this series.
- X / Z axes adopt high rigidity box way and wide span structure to ensure best rigidity and precision.
- 2-step gear box is driven by 37 kW motor spindle, torque can reach up to 4,912 N-m. (opt.)
- Ø 750 mm large size turret disk is indexed by Ø 450 mm curvic couplings, providing strong cutting ability.
- Ø 110 mm rotary quill's tailstock combines with sufficient hydraulic thrust provides stable support for work-piece.
- Chucks are installed on both ends of spindle enables high precision threading for long bar.

		GS-6000	GS-6600		GS-6800
Max. swing diameter	mm		Ø 980		
Max. turning diameter	mm		Ø 880		
Max. turning length	mm		950 / 1,965 / 3,300		
Chuck size		15" (Opt. 18")	20" *1	22"*2	24"*2
Bar capacity	mm	Ø 115	Ø 180	Ø 205	Ø 260
Spindle nose		A2-11	A2-15		A2-15
Spindle motor output (cont. / 30 min.)	kW		30 / 37		
X-axis travel	mm		500		
Z-axis travel	mm		980 / 1,965 / 3,300		

*1 Hydraulic chuck opt. *2 Pneumatic chuck opt.

Specifications are subject to change without notice.

GS-4000 SERIES

Horizontal Turning Centers

- Complete standard size, four different body length and two types of spindle bore provides a total of 8 combinations.
- 30° low center gravity slant bed ensures high rigidity of this series.
- X / Z adopt high rigidity box ways structure and wide span design to ensure best rigidity and precision.
- 2-step gear box is driven by 37 kW motor spindle, torque output can reach 2,923 N-m. (GS-4300)
- Large size turret disk is indexed by Ø 320 mm curvic couplings, providing strong cutting ability.
- Operation-friendly environment, operation panel can be rotated 90° manually and is carried to required position by linear guide way.



Extra wide hardened and ground box ways are directly formed onto the machine bed and saddle during the casting process. The box way design provides the rigidity needed for heavy duty and interrupted turning applications.

C3 class hardened and precision ground ball screws ensure the highest accuracy and durability possible. Plus, pretension on all axes minimizes thermal distortion.

Available programmable base tailstock saves manpower and enables many critical applications to be performed efficiently.

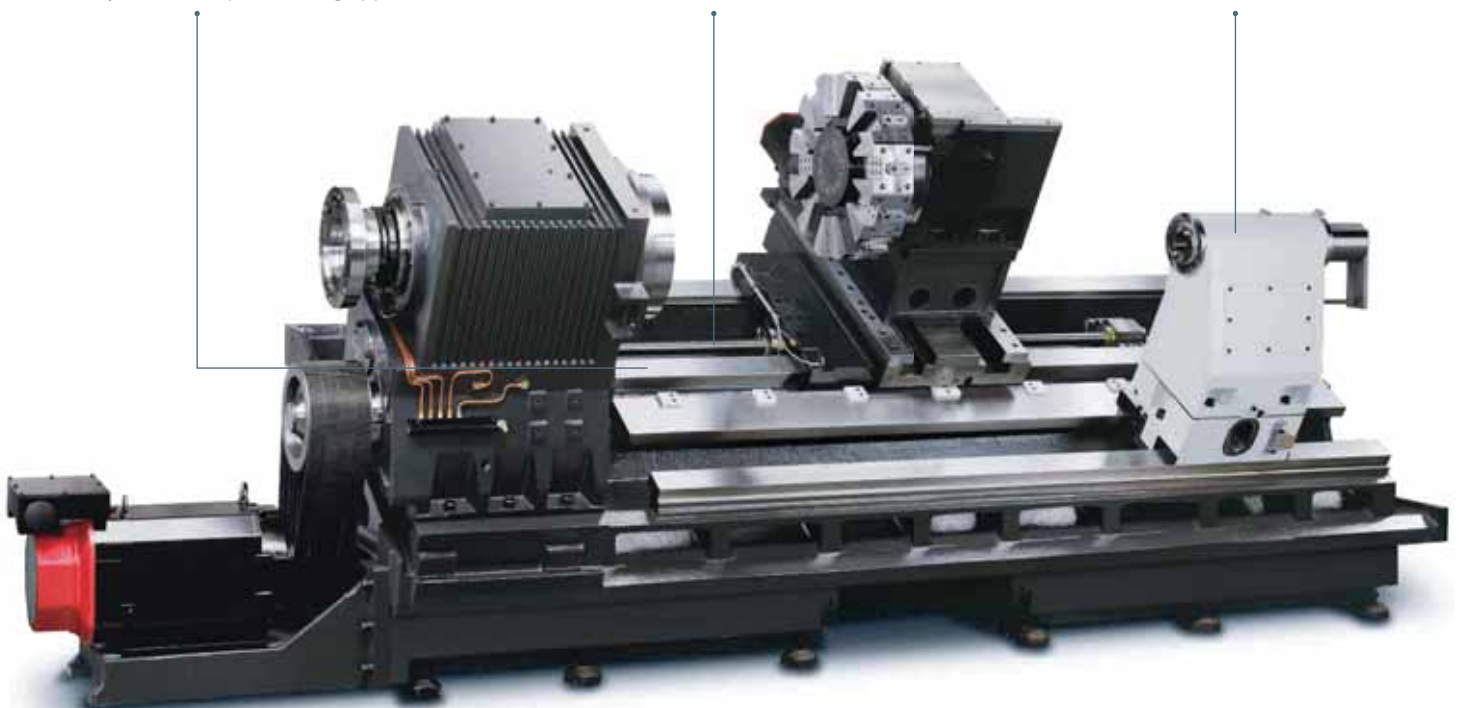



12 Station Live Tooling Turret

Live tooling turret is driven by 7.5 kW spindle motor with sufficient power to complete any difficult machining. (Y-axis model : 5.5 kW)



Comprehensive Machining Ability

Optional sub-spindle provides high-efficiency rear-end machining. Y-axis provides high precision for complex machining tasks.



Twin Chucks Clamping Both Ends

Chuck is installed at both ends of spindle, enabling high precision thread for long bar.

		GS-4000	GS-4300
Max. swing diameter	mm	Ø 770 (Y-axis model : Ø 700)	
Max. turning diameter	mm	Ø 620 (Y-axis model : Ø 460)	
Max. turning length	mm	819 / 1,569 / 2,369 / 3,169 (Standard Turret)	
Chuck size		15" (Opt. 18")	24" (Opt. Pneumatic chuck)
Bar capacity	mm	Ø 115	Ø 165
Spindle nose		A2-11	A2-15
Spindle motor output (cont. / 30 min.)	kW	30 / 37	
X / Y axes travel	mm	350 (Y-axis model : 300) / 120 = ±60	
Z-axis travel	mm	850 / 1,600 / 2,400 / 3,200	

Specifications are subject to change without notice.

GS-2000/3000 SERIES

Horizontal Turning Centers

- 30° low center gravity slant bed ensures high rigidity of this series.
- X / Z axes adopts high rigidity box ways structure and wide span design to ensure best rigidity and precision.
- Various modules such as belt-type spindle, built-in spindle, or ZF gear box, fulfilling different machining.
- X / Z axes is direct driven by high-performance AC server motor, rapid feed rate can reach 30 m/min.
- 12 station servo turret adjacent / opposite tool changing only takes up to 0.3 and 0.8 sec.
- High rigidity tailstock or servo tailstock ensure best support for work-piece.
- Optional live tool turret, C-axis, sub-spindle, Y-axis, front and back of work-piece can be finished in one set-up, finishing complex milling machining.



GS-2000 / GS-3000 V.S Previous Model

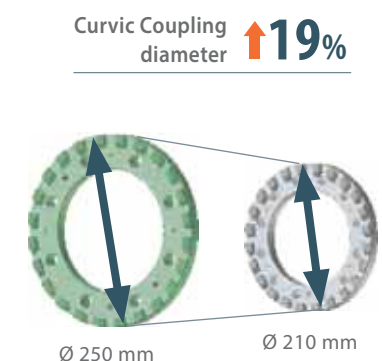
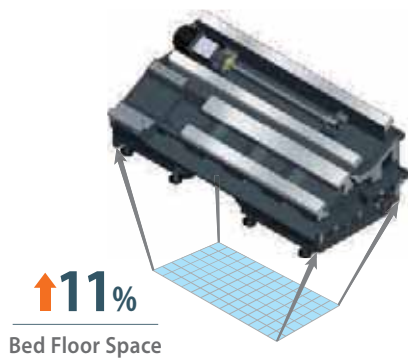



Heavy Cutting



7

Depth of Cut (mm)

0.4 **417**

Feed Rate (mm/rev.) Speed (rpm)

Tapping



M24 x P2.5

Tool Dia. (mm)

240 **530**

Tool Speed (r/min.) Speed (rpm)

U-drill



50

Tools Diameter (mm)

0.15 **764**

Feed Rate (mm/rev.) Speed (rpm)

End Mill



15

Depth of Cut (mm)

260

Feed Rate (mm/rev)

20

Tool Dia. (mm)

640

Speed (rpm)

		GS-2000	GS-2600	GS-2800	GS-3300	GS-3600
Max. swing diameter	mm			Ø 630		
Max. turning diameter	mm			Ø 570		
Max. turning length	mm		780 / 1,530			746 / 1,496
Chuck size		8"	10"	10"	12"	15"
Bar capacity	mm	Ø 51	Ø 65	Ø 75	Ø 90	Ø 105
Spindle nose		A2-6		A2-8		A2-11
Spindle motor output (cont. / 30 min.)	kW	15 / 18.5		15 / 18.5 (Opt. 18.5 / 22)	18.5 / 22	
X / Y axes travel	mm	300 (Y-axis model : 280) / 100 = ±50				
Z-axis travel	mm	780 / 1,530				
X / Z axes rapid feed rate	m/min.	30				

Specifications are subject to change without notice.

GA SERIES

Horizontal Turning Centers

- MEEHANITE casting body combines 30° saddle provides solid foundation for spindle head, turret, and tailstock.
- X / Z axes adapts high rigidity box ways structure and wide span design to ensure best rigidity and precision.
- Spindle torque output is 2 ~ 4 times higher than same level model. Optional ZF gear box is also available for the GA-3000 series, fulfilling heavy cutting.
- 12 tool servo turret, adjacent/ opposite tool changing only takes up to 0.2 and 0.5 sec.
- Programmable tailstock design, both tailstock positioning and quill are programmable*1

*1 GA-2000C is not available.

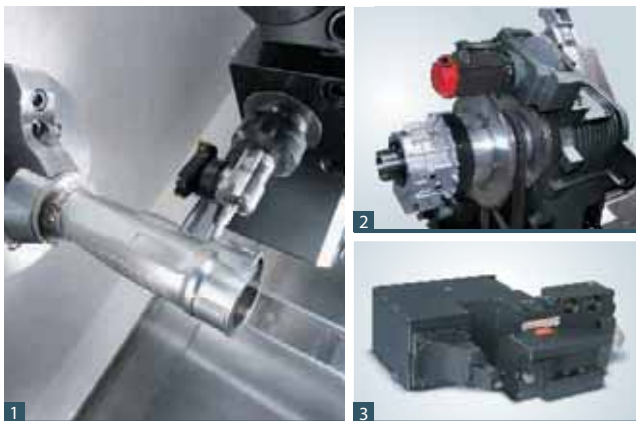

- 1 12 stations live tooling turret offers 12 stations available for live tooling (live tooling tools rotate in working position only).
- 2 Adopt C_f-axis with disk break system can provide the strongest rigidity C-axis function.
- 3 Optional Goodway dual-face turning holder allow both sides of a disk-type work-piece to be machined at the same time.

GA-2000C Compact Design Series

- ▣ Minimal foot-print and rear-exit chip conveyor design.



- ▣ Featured robotic arm, loading and unloading can be done in one setup which is pretty safe and quick to fulfill needs of mass production.





GA-2000

Material : S45C

O.D. Before Cut	O.D. After Cut	Spindle Speed	F / Rev.	Depth of Cut (side)	Spindle load
Ø 108 mm	Ø 96 mm	500 rpm	0.30 mm	6 mm	97 %
Ø 96 mm	Ø 82 mm	550 rpm	0.32 mm	7 mm	112 %

GA-3000

O.D. Before Cut	O.D. After Cut	Spindle Speed	F / Rev.	Depth of Cut (side)	Spindle load
Ø 144 mm	Ø 120 mm	729 rpm	0.40 mm	12 mm	65 %

		GA-2000	GA-2600	GA-2800	GA-3000	GA-3300	GS-3600
Max. swing diameter	mm	Ø 580			Ø 600		
Max. turning diameter	mm	Ø 350			Ø 500		
Max. turning length	mm	309 / 624 / 1,204	291 / 606 / 1,186	260 / 575 / 1,155	629 / 929 / 1,229	624 / 924 / 1,224	596 / 896 / 1,196
Chuck size		8"	10"	10"	10" (12")	12" (15")	15"
Bar capacity	mm	Ø 51	Ø 65	Ø 75	Ø 75	Ø 90	Ø 105
Spindle nose		A2-6	A2-8			A2-11	
Spindle motor output (cont. / 30 min.)	kW	11 / 15			18.5 / 22		
Turret / Live turret stations	T	10 (Opt. 12) / 12					
X-axis travel	mm	205			260		
Z-axis travel	mm	350 / 650 / 1,230			630 / 930 / 1,230		

Specifications are subject to change without notice.

GLS-1500 SERIES

Horizontal Turning Centers



- Compact machine structure, compound live turret, C-axis, sub-spindle, and Y-axis function.
- 30° low center gravity slant bed ensures high rigidity of this series.
- X / Y / Z axes use high-precision linear guide way, providing high precision, low friction, and high speed movement.
- X / Y / Z axes are driven by high performance AC servo motor, rapid feed rate can reach up to 30 m/min.
- 12 station servo turret, optional 24 tool turret, live turret, and gang tooling system are also available.

		GLS-1500	GLS-2000
Max. swing diameter	mm	Ø 560	
Max. turning diameter	mm	Ø 390	
Max. turning length	mm	330 / 630	
Chuck size		6" (Big-bore)	8" (Big-bore)
Bar capacity	mm	Ø 51	Ø 65
Spindle nose		A2-5	A2-6
Spindle motor output (cont. / 30 min.)	kW	11 / 15	
Turret / Live tooling turret stations	T	12 or 24 / 12	
X / Y axes travel	mm	230 / 70 = ±35	
Z-axis travel	mm	330 / 630	

Specifications are subject to change without notice.

GLS-2800 SERIES

Horizontal Turning Centers



- Sufficient machining area and is equipped with live tool turret, C-axis, sub-spindle, Y-axis providing complex machining ability.
- 30° low center gravity slant bed ensures high rigidity of this series.
- X / Y / Z axes use high-precision linear guide way, providing high precision, low friction, and high speed movement.
- X / Y / Z axes are driven by high performance AC servo motor, rapid feed rate can reach up to 30 m/min.
- 12 tool live turret, optional live turret, C-axis as turning centers are also available.

		GLS-2800	GLS-3300
Max. swing diameter	mm	Ø 760	
Max. turning diameter	mm	Ø 440	
Max. turning length	mm	722	713
Chuck size		10"	12"
Bar capacity	mm	Ø 75	Ø 90
Spindle nose		A2-8	A2-8
Spindle motor output (cont. / 30 min.)	kW	11 / 15	15 / 18.5
Turret / Live tooling turret stations	T	12 or 10 / 12	
X / Y axes travel	mm	250 (Live tooling turret model : 270) / 100 = ±50	
Z-axis travel	mm	750	

Specifications are subject to change without notice.

GA-W SERIES

High Performance Wheel Turning Centers

- Hydraulic chuck buckle jaws for wheel turning centers.
- High rigidity vibrate resistant tool and servo turret.
- 30° low center gravity bed combined with X-axis saddle.
- High rigidity box way structure.
- High performance side chip conveyor.

GA-3600/W24	
Wheel size	13" ~ 24"
Max. swing diameter	Ø 930 mm
Chuck size	15"
Spindle nose	A2-11
Spindle speed	2,500 rpm
Spindle motor output	45 kW
Turret station	10 T



GS-200 SERIES

High Performance Horizontal Turning Centers

- High rigidity 30° box way slant bed.
- 12 tool servo turret and programmable quill and body tailstock.
- Optional live tooling turret / sub-spindle / Y-axis.



GLS-150 SERIES

High Speed Horizontal Turning Centers

- High rigidity 30° slant bed.
- 12 tool servo turret / programmable tailstock.
- Optional live tooling turret / Y-axis.

	GS-200	GS-260	GS-280
Max. swing diameter	Ø 670 mm		
Max. turning diameter	Ø 420 mm		
Max. turning length	591 / 1,191 mm	560 / 1,160 mm	534 / 1,134 mm
Chuck size	8"	10"	10"
Hole through spindle	Ø 51 mm	Ø 65 mm	Ø 75 mm
Spindle nose	A2-6	A2-8	
Spindle motor output (cont. / 30 min.)	11 / 15 kW		
X / Y axes travel	240 mm (Y-axis model : 270 mm) / 100 = ±50 mm		
Z-axis travel	600 / 1,200 mm		
X / Z axes rapid feed rate	20 / 24 m/min.		

	GLS-150	GLS-200	GLS-260
Max. swing diameter	Ø 500 mm		
Max. turning diameter	Ø 360 mm		
Max. turning length	500 mm		
Chuck size	6" (Big-bore)	8" (Big-bore)	10"
Hole through spindle	Ø 51 mm	Ø 65 mm	Ø 65 mm
Spindle nose	A2-5	A2-6	A2-8
Spindle motor output (cont. / 30 min.)	11 / 15 kW		
X / Y axes travel	210 mm (Y-axis model : 195) / 70 = ±35 mm		
Z-axis travel	520 mm		
X / Z axes rapid feed rate	30 m/min.		



GCL-2 SERIES

High Performance Lathe

- Over 10,000 models sold worldwide.
- Over 30 years of user experience, reliable function performance.
- Low gravity box way structure.

	GCL-2
Max. swing diameter	Ø 400 mm
Max. turning diameter	Ø 230 mm
Max. turning length	300 / 600 mm
Chuck size	8"
Spindle nose	A2-6
Spindle motor output	11 / 15 kW (cont. / 30 min.)
X-axis travel	125 mm
Z-axis travel	320 / 620 mm
X / Z axes rapid feed rate	20 m/min.



TS-150 SERIES

High Speed Gang Type Turning Centers

- Compact structure for small cover area.
- High speed gang tooling turret design.
- High rigidity 30° slant bed.

	TS-150
Max. swing diameter	Ø 330 mm
Max. turning length	290 mm
Bar capacity	Ø 45 mm
Chuck size	6" or 42 collet
Spindle motor output (cont. / 15 min.)	5.5 / 7.5 kW
X / Z axes travel	305 / 320 mm
X / Z axes rapid feed rate	24 m/min.

* Opt. servo turret or live tooling turret
Specifications are subject to change without notice.

GRINDER



GRU Series P21

Plunge CNC Cylindrical Grinder
Max. external grinding dia. |
Ø 190 mm



GRA Series P21

Angular Cylindrical Grinder
Max. external grinding dia. |
Ø 190 mm



GRW Series P21

Traveling Head Cylindrical Grinder
Max. external grinding dia. |
Ø 400 mm



GRC Series P23

Center Hole Grinder
Work-piece length
| 50 ~ 1,500 mm



GRI Series P24

CNC Internal Grinder
Inside diameter range
| Ø 6 ~ 150 mm

MULTI-AXIS TURNING CENTERS



GTH Series P29

Parallel Twin Spindle
Turning Centers
Chuck size | 10"



GMS Series P25

Tool Spindle Type
5-Axis Turning Centers
Chuck size | 8" / 10"



GTW Series P27

Turret / Gang Tooling
Turning Centers
Chuck size | 6"



GTZ Series P31

Twin Spindles & Turrets
Turning Centers
Chuck size | 6" / 8"



GTS Series P32

Twin Spindles & Turrets
Turning Centers
Chuck size | 6" / 8" / 10"

SWISS TURNING CENTERS



SW-42 Series P43

Multi-tasking
SWISS Turning Centers
Max. machining dia. | Ø 42 mm



SW-32 Series P43

Multi-tasking
SWISS Turning Centers
Max. machining dia. | Ø 32 mm



SW-20 Series P43

Multi-tasking
SWISS Turning Centers
Max. machining dia. | Ø 20 mm



SD-20 Series P45

Compact
SWISS Turning Centers
Max. machining dia. | Ø 20 mm



SD-16 Series P45

Compact
SWISS Turning Centers
Max. machining dia. | Ø 16 mm

VERTICAL TURNING CENTERS



SUPER GV Series P41

Super Size
Vertical Turning Centers
Table diameter
Ø 2,000 ~ 8,000 mm



GV-1 Series P39

Heavy-Duty
Vertical Turning Centers
Table diameter
Ø 1,100 ~ 2,000 mm



GVF Series P40

Super Rigid
Vertical Turning Centers
Table diameter
Ø 1,100 ~ 2,000 mm



GV-1000 Series P37

Super Rigid
Vertical Turning Centers
Chuck size | 18" ~ 32"



GV-780 Series P36

High Speed
Vertical Turning Centers
Chuck size | 15" / 18"

HORIZONTAL TURNING CENTERS



HA Series P47

Flat-bed
Turning Centers

Chuck size | 24" ~ 63"



GS-8000 Series P49

Heavy-Duty Super Size
Turning Centers

Chuck size | 18" / 24"



GS-6000 Series P50

Heavy-Duty
Turning Centers

Chuck size | 15" ~ 24"



GS-4000 Series P51

Maximum Performance
Turning Centers

Chuck size | 15" ~ 24"



GS-3000 Series P53

Maximum Performance
Turning Centers

Chuck size | 12" / 15"



GS-2000 Series P53

Maximum Performance
Turning Centers

Chuck size | 8" / 10"



GS-200 Series P59

Ultra Performance
Turning Centers

Chuck size | 8" / 10"



GA-3000 Series P55

High Performance
Turning Centers

Chuck size | 10" / 12" / 15"



GA-2000 Series P55

High Performance
Turning Centers

Chuck size | 8" / 10"



GCL-2 Series P60

High C/P Value
Lathe

Chuck size | 8"



GLS-3300 Series P58

High Speed
Turning Centers

Chuck size | 12"



GLS-2800 Series P58

High Speed
Turning Centers

Chuck size | 10"



GLS-1500 Series P57

High Speed
Turning Centers

Chuck size | 6" / 8"



GLS-150 Series P59

High Speed
Turning Centers

Chuck size | 6" / 8" / 10"



TS-150 Series P60

Gang Type
Turning Centers

Chuck size | 6"



GV-500 Series P35

High Speed
Vertical Turning Centers

Chuck size | 12" / 15"



GVI Series P33

Inverted Vertical
Combination Turning
Centers

Chuck size | 12"

WHEEL TURNING CENTER



GA-W Series P59

High Performance
Wheel Turning Centers

Chuck size | 15"

VERTICAL MACHINING CENTER



MLV Series

Super Rigid
Vertical Machining Centers

Travel | X: 610 ~ 1,020 mm
| Y: 610 mm
| Z: 610 mm

TAPPING CENTER



TLV Series

High Speed
Tapping Centers

Travel | X: 500 / 700 mm
| Y: 400 mm
| Z: 300 mm



GOODWAY MACHINE CORP.

HEADQUARTERS 40752 No.13, 5th Rd., Taichung Industrial Park, Taichung, Taiwan
Website : www.GOODWAYCNC.com

CTSP Branch 40771 No.38, Keyuan Rd., Central Taiwan Science Park, Taichung, Taiwan
TEL : +886-4-2463-6000
FAX : +886-4-2463-9600
E-mail : goodway@goodwaycnc.com

GOODWAY MACHINE (WUJIANG) CORP.

215200 No.4888, East Lake Taihu Ave., Wujiang Economic and Technological Development Zone, Jiangsu, China
TEL : +86-512-8286-8680
FAX : +86-512-8286-8620
E-mail : goodway@goodwaycnc.cn