

VP SERIES

Ultra Performance Bridge Type Machining Centers



AWEA MECHANTRONIC CO., LTD.

HEADQUARTERS

629, Suezhetou Section, Kwanpu Rd., Wenshan Li,
Hsinpu, Hsinchu 305, Taiwan

TEL : +886-3-588-5191

FAX : +886-3-588-5194

Website : www.awea.com

CENTRAL TAIWAN SCIENCE PARK BRANCH

15, Keyuan 2nd Rd., Central Taiwan Science Park,
Taichung 407, Taiwan

TEL : +886-4-2462-9698

FAX : +886-4-2462-8002

E-mail : sales@awea.com

ISO 9001



ISO 14001



AGENT



ULTRA PERFORMANCE BRIDGE TYPE VERTICAL MACHINING CENTER

Introducing AWEA with mature manufacturing abilities and advanced technology skills, the VP series bridge type vertical machining centers combine advanced concept of design and stable machine structure provide you The Ultimate Machining Power[®] at the most compact floor space. It is one of the most cost-effective models. All series are adopted with modular design, the full product line provides you high performance, high productivity machining solutions to meet your demands of today and tomorrow. It can be broadly applied in the automotive, precision die & mold, aerospace, and energy industries., etc.

VP Series Product Map (X / Y / Z axes travel)

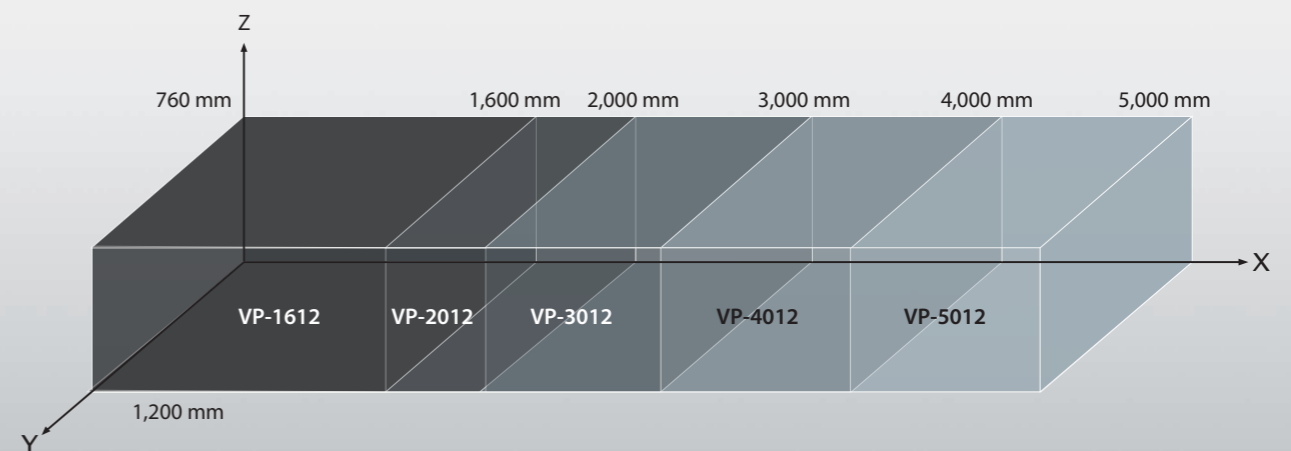

VP Series 1612 / 2012 / 3012 / 4012 / 5012

Ultra Performance Bridge Type Vertical Machining Center

Thanks to our advanced developing skills and strict assembly process, gives the VP series ultra performance bridge type vertical machining center optimum rigidity, accuracy and efficiency.

- The modular spindle design provides cutting flexibility for various working conditions.
- Super rigidity linear guide ways on the X, Y axes.
- The Z-axis is adopted with super rigidity box way which is hardened and precisely ground suitable for heavy-duty cutting conditions. (Opt. : The Z-axis can be adopted with roller type linear guide ways if equipped with high speed direct-driven spindle.)



- Fully enclosed splash guard w/o roof



- Fully enclosed splash guard with roof (Opt.)

Ultra Performance Bridge Type Vertical Machining Center

- The Finite Element Analysis (FEA) provides optimum machine design and light-weighted structure advantages while ensuring best machine rigidity.
- Optimized bridge and base casting structure with hand scraped contact surfaces ensure optimum assembly precision, structural rigidity and load balancing.*1
- Rib reinforced working table restrains vibration while increasing machining stability.

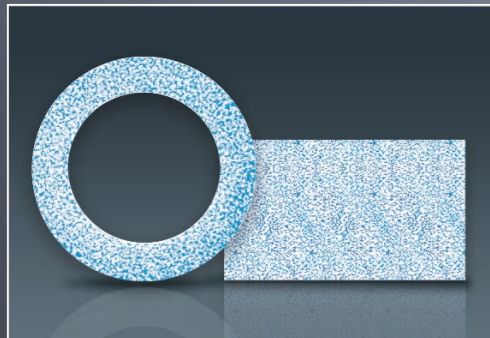

■ Hand Scraping Rubbing Data

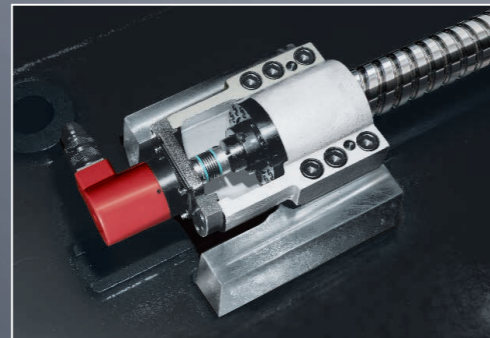

■ Precision Feedback System
The semi-closed loop circuit system which the ball screw end is directly connected to the encoder ensures high positioning accuracy.

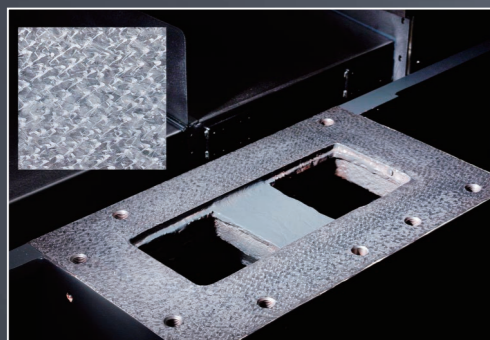

■ The connecting area between columns and bed are precisely hand scraped.

*1 : VP-5012 use optimum reinforced welded bed with full annealing process.

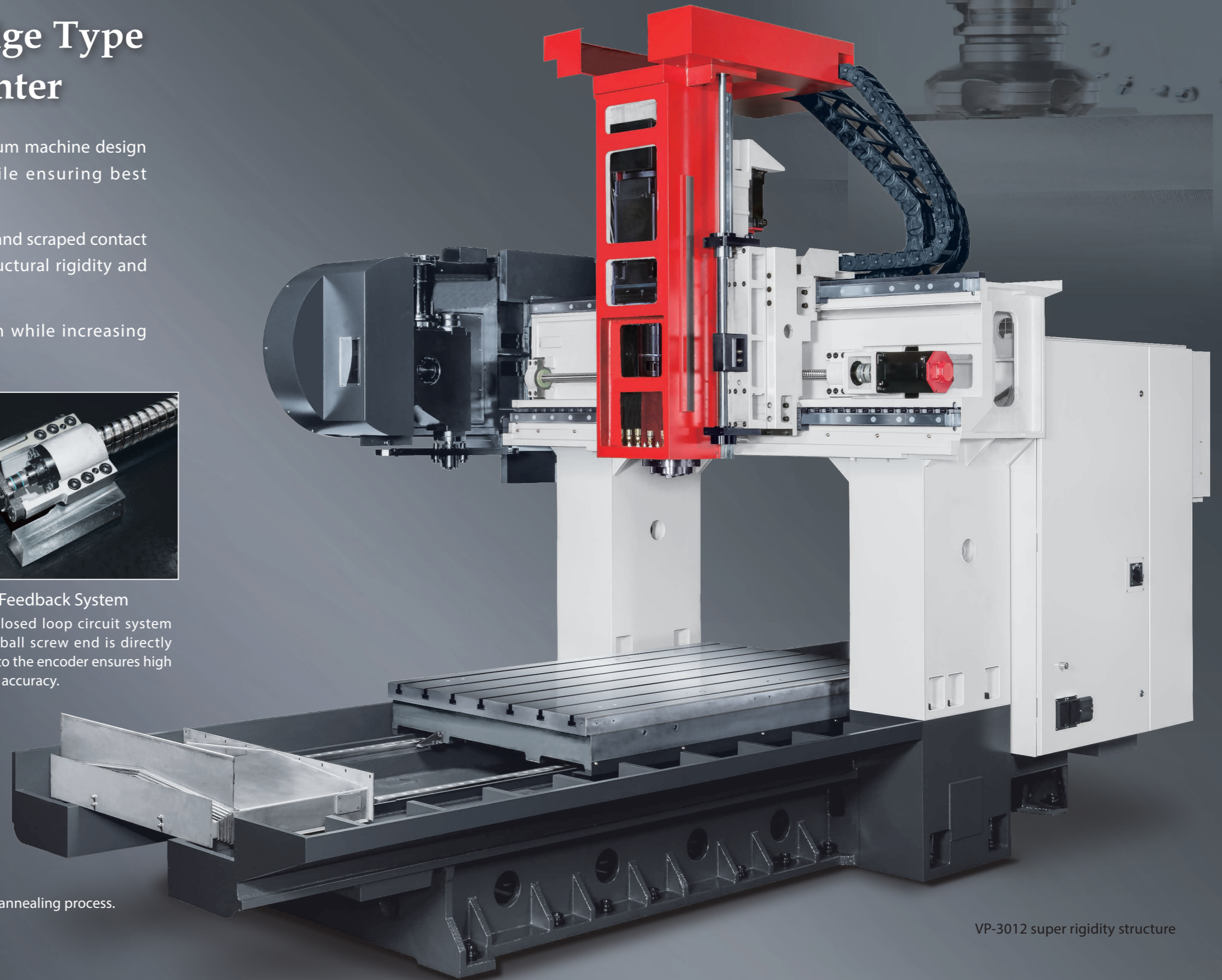

VP-3012 super rigidity structure

Optimum Spindle System

Powerful Cutting Capability

Inner-rail embraced structure provides super rigidity and gains good stress flow which minimizes overhang and vibration issues. The Y-axis linear guide ways offset from each other increases structural rigidity reduces distance between spindle to cross beam enhances overall cutting performance.

Centro-symmetric Main Spindle System

Unique head design which the main spindle, spindle motor, ball screw and hydraulic counter balance cylinders are symmetrically placed. Hereby preventing thermal distortion and minimizing deflection. Assuring accuracy and heavy cutting capability.

■ Centro-symmetric main spindle system design

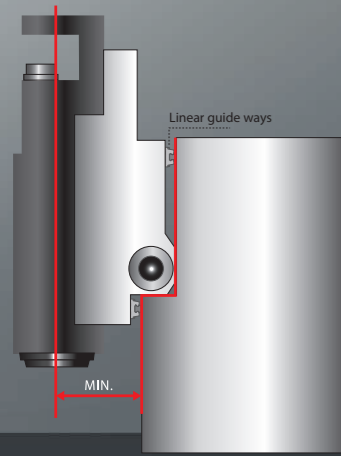
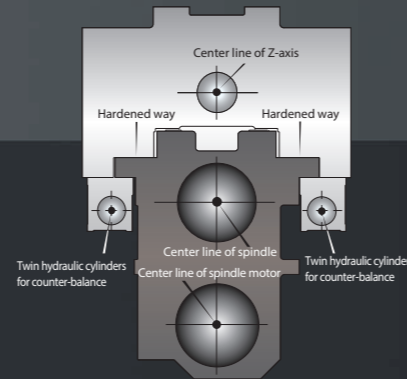

■ Y-axis sectional linear guide ways design

NC Intelligence

i Console

AWEA's self-developed *i Console* intelligent software enhancement system provides you with a user-friendly interface, real-time machine status information and diagnosis functions. It not only effectively reduces complex working process but also increases intelligent machining abilities.

Option



(For 10.4" LCD only)



■ Optional long nose spindle provide stronger cutting rigidity with reduced tool extension.

BT40 / BT50 6,000 rpm Gear Spindle

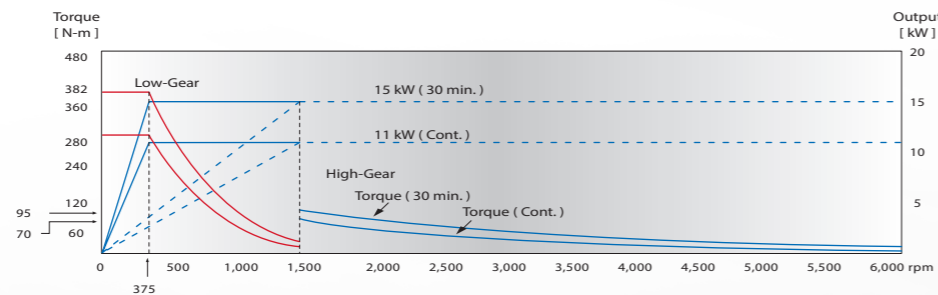

BT50 10,000 rpm Direct-driven Spindle

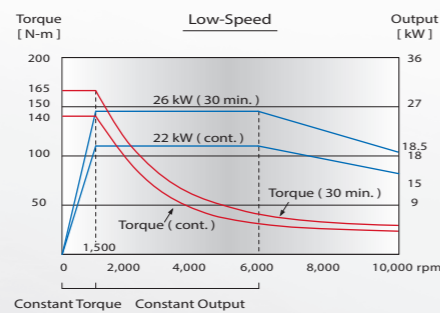

BT40 15,000 rpm Direct-driven Spindle

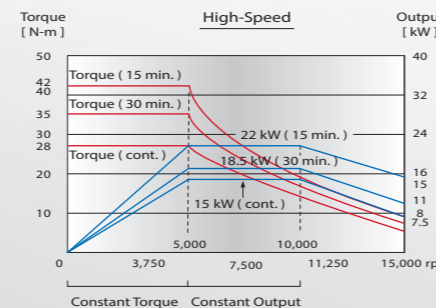
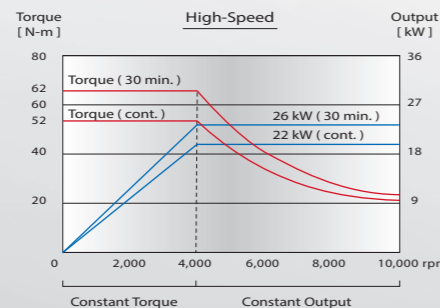
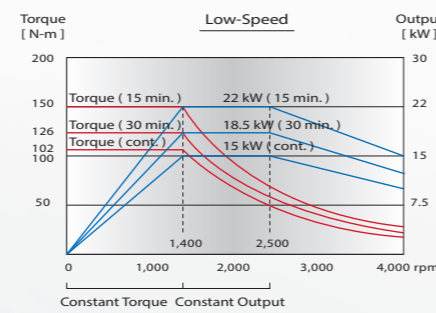

Multiple Functions Status Display

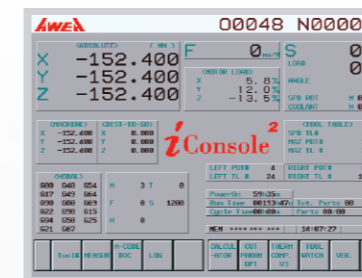

- Real time operation information
- Tool list
- Work piece measurement
- M code illustration
- PLC function
- Calculator
- CNC optimize parameter (Opt.)
- Spindle thermal compensation (Opt.)

Circular Work Piece Measurement

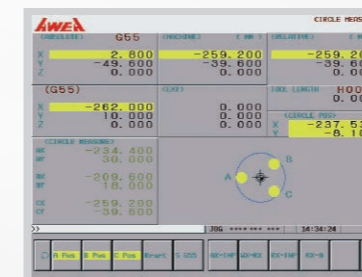

The circular work piece program can calculate the center coordinate of a work piece by measuring point A, B and C coordinates.

Rectangular Work Piece Measurement

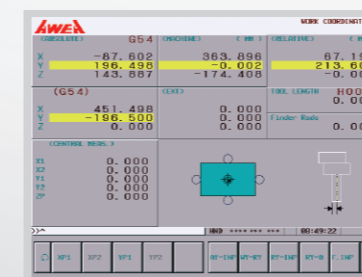

The rectangular work piece program can calculate the center coordinate and the slant angle of a work piece by measuring point A, B, C, D and E coordinates; the calculated center coordinate can be inputted into the work piece coordinate program (G54 ~ G59).

Trouble Shooting

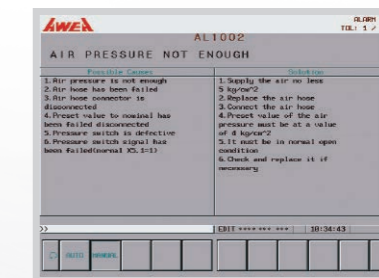

When the alarm appears, the program will display the breakdown cause and a troubleshooting procedure. Users can easily troubleshoot minor problems to save machine shutdown time.

CNC Optimized Parameter

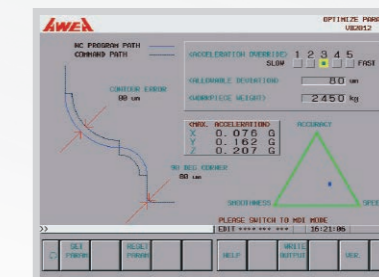

From rough cutting to fine machining, users can select different working modes, determine the allowable tolerance and the weight of the work piece, based on your desired working condition.

Manual Tool Length Measurement

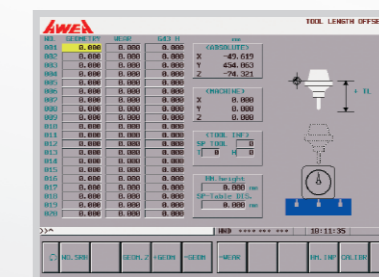

After manually measuring the tool length, the controller will automatically calculate the tool tip position and input the data into the tool length offset table.

Dimensions

(Unit : mm)

Table Dimensions

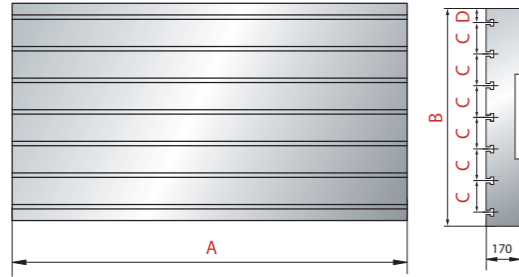

Model	A	B	C	D
VP-1612	1,600			
VP-2012	2,000			
VP-3012	3,000	1,100	160	70
VP-4012	4,000			
VP-5012	5,000			

Tool Shank and Pull Stud Dimensions

BT50

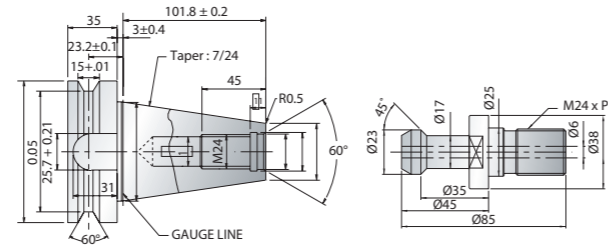

DIN69871-A (#50) (Opt.)

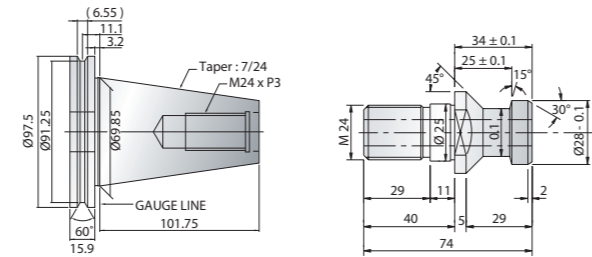

T-slot Dimensions

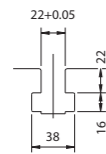

Machine Dimensions

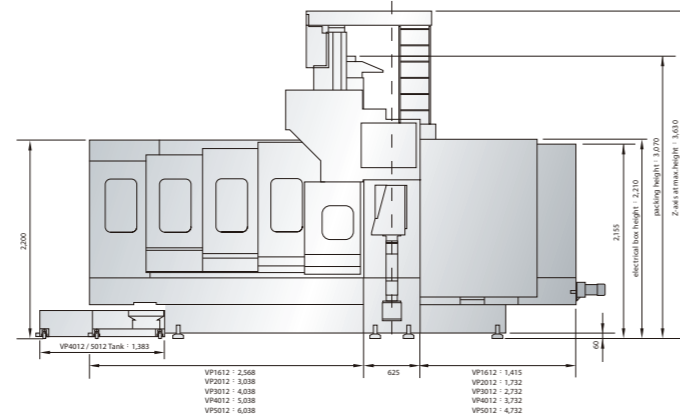
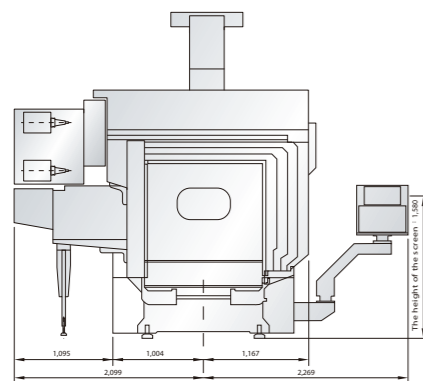
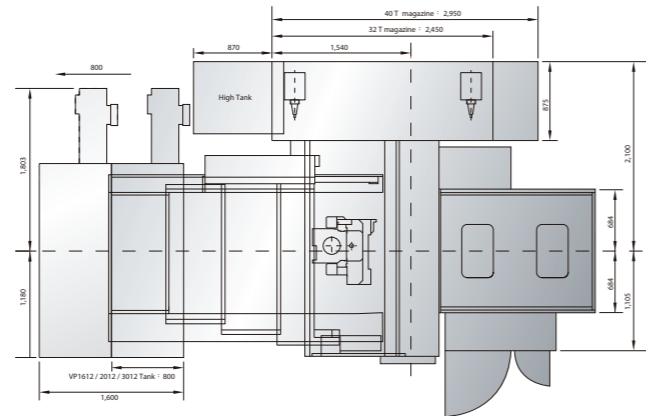

		VP-1612	VP-2012	VP-3012	VP-4012	VP-5012
SPECIFICATIONS						
X-axis travel	mm	1,600	2,000	3,000	4,000	5,000
Y-axis travel	mm			1,200		
Z-axis travel	mm			760		
Distance from spindle nose to table top	mm			200 ~ 960		
Distance between columns	mm			1,300		
WORKING TABLE						
Table size (X direction)	mm	1,600	2,000	3,000	4,000	5,000
Table size (Y direction)	mm			1,100		
Table load capacity	kg	3,000	3,500	4,500	6,000	8,000
SPINDLE						
Spindle power (Cont. / 30 min.)	kW			11 / 15		
Spindle speed	rpm			Gear Spindle 6,000		
Spindle taper				BT50		
FEED RATE						
X-axis rapid feed rate	m/min	20	20	20	10	8
Y-axis rapid feed rate	m/min			20		
Z-axis rapid feed rate	m/min			20		
Cutting feed rate	m/min	10	10	10	10	8
TOOL MAGAZINE						
Tool magazine capacity	T			32 (Opt. 24 / 40)		
Max. tool diameter / adj. pocket empty	mm			Ø 125 / Ø 229		
Max. tool length (from gauge line)	mm			350		
Max. tool weight	kg			15		
ACCURACY						
Positioning accuracy (JIS B 6338)	mm			± 0.010 / Full travel		
Positioning accuracy (VDI 3441)	mm			P ≤ 0.02 / Full travel	P ≤ 0.03 / Full travel	P ≤ 0.04 / Full travel
Repeatability (JIS B 6338)	mm			± 0.003		
Repeatability (VDI 3441)	mm			Ps ≤ 0.015	Ps ≤ 0.02	Ps ≤ 0.03
GENERAL						
Power requirement		AC 220 ± 10 % 3 phase, 60 / 50 Hz / 40 kVA				
Pneumatic pressure requirement (min.)	kg/cm ²	5 ~ 7				
Hydraulic unit tank capacity (pump)	liter (HP)	120 (7.5)				
Lubrication oil tank capacity	liter	4.5				
Coolant tank capacity (pump)	liter (HP)	370 (1)				
Machine weight	kg	14,000	16,000	20,000	24,000	28,000

Specifications are subject to change without notice.

Standard Accessories

- Spindle cooling system
- Centralized automatic lubricating system
- Fully enclosed splash guard w/o roof
- Coolant system with pump and tank
- Twin screw type chip auger
- Caterpillar type chip conveyor and bucket
- Foundation bolt kit
- Tool box
- Alarm light
- Air gun
- Automatic power off system

Optional Accessories

- Direct-driven spindle : 15,000 rpm (#40) / 10,000 rpm (#50)
- Direct-driven spindle (Long Nose) : 10,000 rpm (#50)
- Spindle taper : DIN50 / CAT50 / ISO50
- Column raiser 200 mm
- Tool magazine 24T / 40T
- X / Y / Z axes optical linear scale (HEIDENHAIN)
- Spindle thermal compensation (must order linear scale)
- Coolant through the tool adapter
- Coolant through the spindle (Form A)
- Automatic tool length measurement
- Automatic work piece measurement
- CNC rotary table
- Oil skimmer
- Oil mist cooling system
- Fully enclosed splash guard with roof
- Extension door
- MITSUBISHI, HEIDENHAIN, SIEMENS controller