

SD / SW SERIES

Maximum Performance SWISS Turning Centers



MAXIMUM PERFORMANCE SWISS TURNING CENTERS

With leading technology and high quality components. Goodway Swiss Turning Center provides the best solution for those work pieces smaller than 42 mm. Additional, SD & SW series are not only with super rigid body, faster moving, and variety tooling selection but also available with sub-spindle, live tooling and bar-feeder to accomplish today and tomorrow's most demand.



(SD-16 series model shown.)

- ▶ Fully enclosed splashguards keep chips and coolant contained for a safe clean working environment.
- ▶ All spindle and servo motors, are FANUC high performance components to ensure peak machining performance and accuracy.
- ▶ C3 class hardened and precision ground ball screws ensure the highest accuracy and durability possible. Plus, pretension on all axes minimizes thermal distortion.
- ▶ The auto lubrication system delivers metered amounts of lubrication to the slide ways, ball screws, and vital components. Distribution is automatically shut off during idling to prevent waste.
- ▶ Optional A/C to control the electrical cabinet's temperature and humidity which can extend the life of electrical components inside efficient.

MACHINING VARIATIONS

1
2

SD series

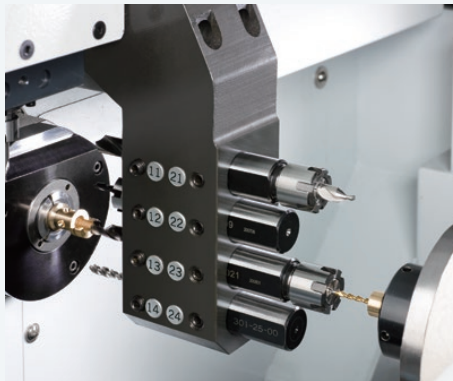

▶ Main & Sub-spindle simultaneous drilling and tapping

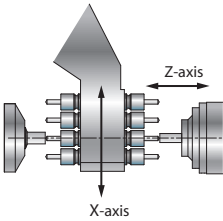

▶ Side milling & tapping

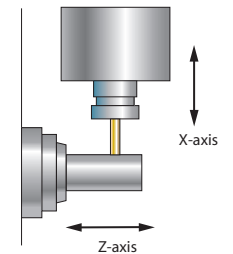

SW series

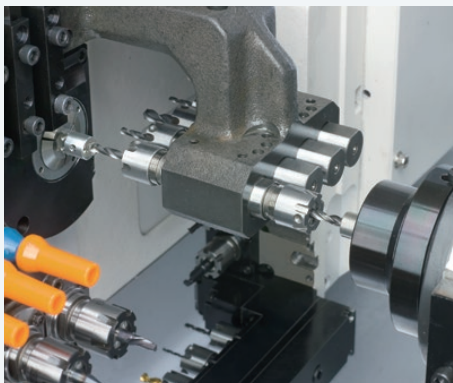

▶ Main & Sub-spindle simultaneous drilling and tapping

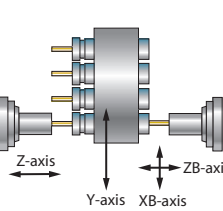

▶ Side milling & tapping

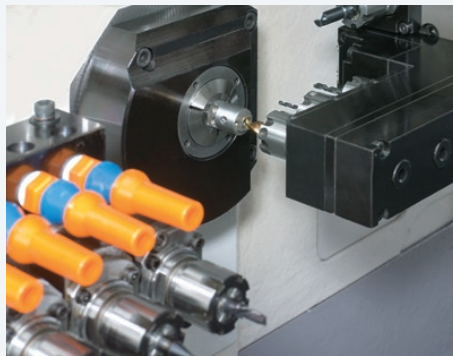
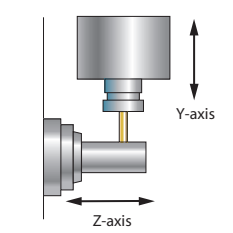

▶ Front offset drilling and tapping

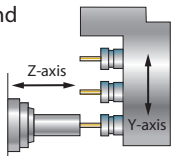

▶ Rear offset drilling and tapping

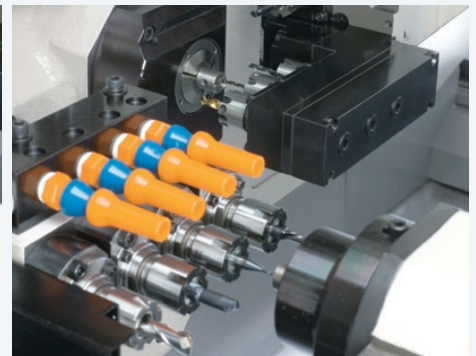
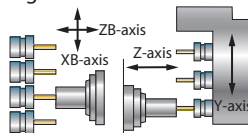

▶ Main & Sub-spindle simultaneous milling

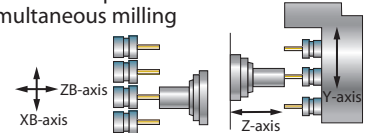

	SD-16	SD-20	SW-20	SW-32	SW-42
Sub-spindle	O	O	O	O	O
Main & Sub-spindle simultaneous machining	O	O	O	O	O
Radial live tool attachment	S	S	S	S	S
Rear-end tool attachment	O	O	O	O	O
Spindle C-axis control	S	S	S	S	S
Module spindle design	-	-	-	O	-
U-drill device	-	-	-	S	-

S: Standard O: Option -: Not Available

SD SERIES TOOL SYSTEM

- ▶ SD series is designed with maximum performance, minimum floor space and easy to operation. Also available with live tooling, sub-spindle and C-axis to provide the mostly friendly working condition.

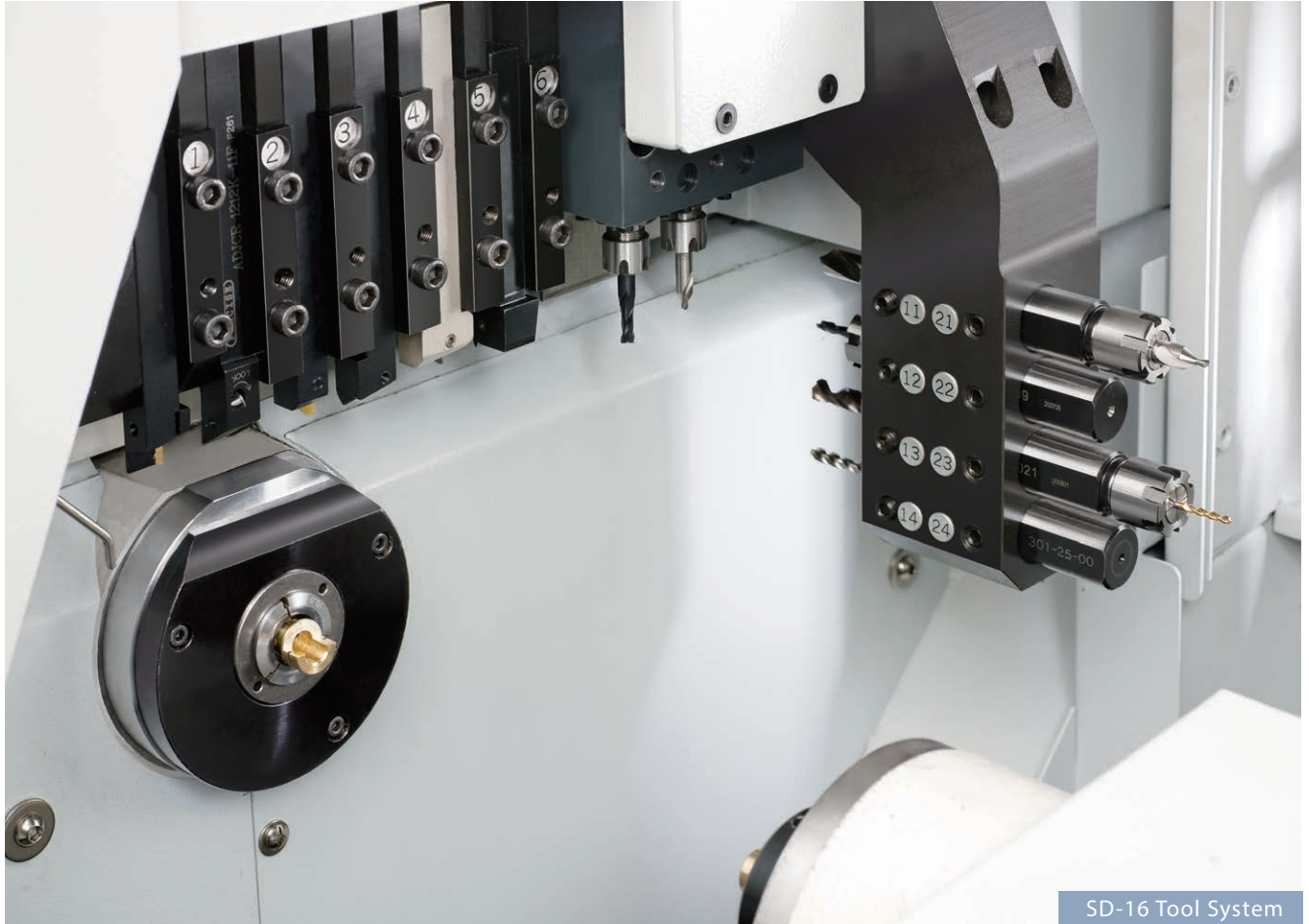

SD-16 Tool System

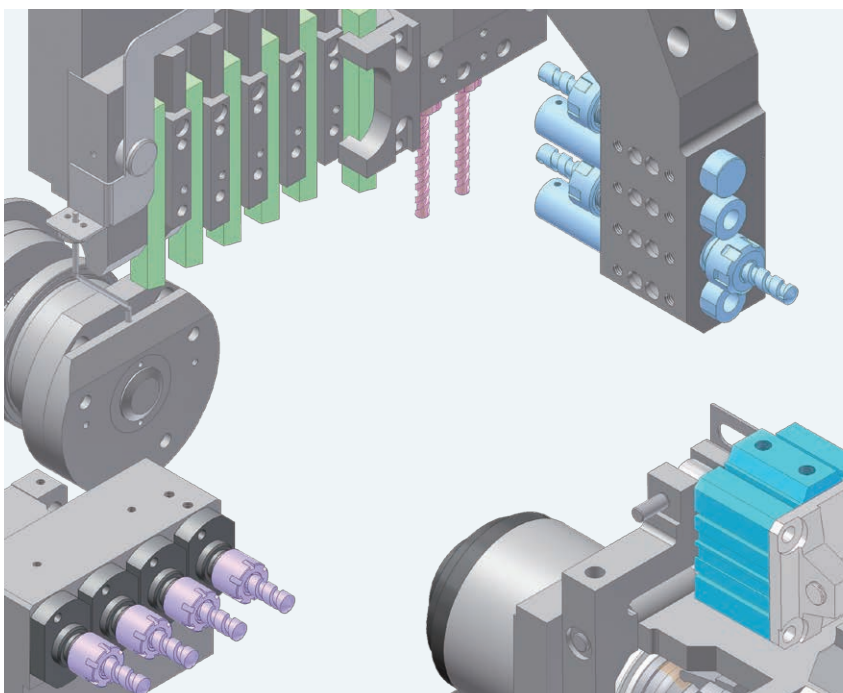

- O.D. Tool
- I.D. Tool
- Radial Live Tool
- Rear Tool

TOOL POST

Tooling System	SD-16	SD-20
O.D. tool	6*1	5*2
Front-end working tool	4	4
Rear-end working tool	4 (Max.)	4 (Max.)
Radial live tool	2*1	3*2
Rear-end Tooling System		
Rear-end working tool	4	4

*1 O.D. tool : □ 12 mm, live tool ER11

*2 O.D. tool : □ 10 mm, live tool ER11x2, ER16x2

- ▶ SD series is design with pneumatic system instead of hydraulic system to achieve our goal that with environment friendly, safety and easy to maintenance.
- ▶ X and ZB axes, the guide ways is dovetail box way that made under heat treatment and super high precision grinding. And the slide ways are bonded with Turcite B to eliminate stick-slip, minimize wear and maintain long term accuracy.
- ▶ Other axes are using high precision linear guide way. It provides high accuracy positioning no matter it is in high or low speed.

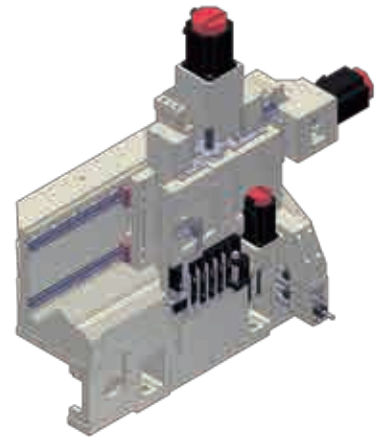

Spindle Output

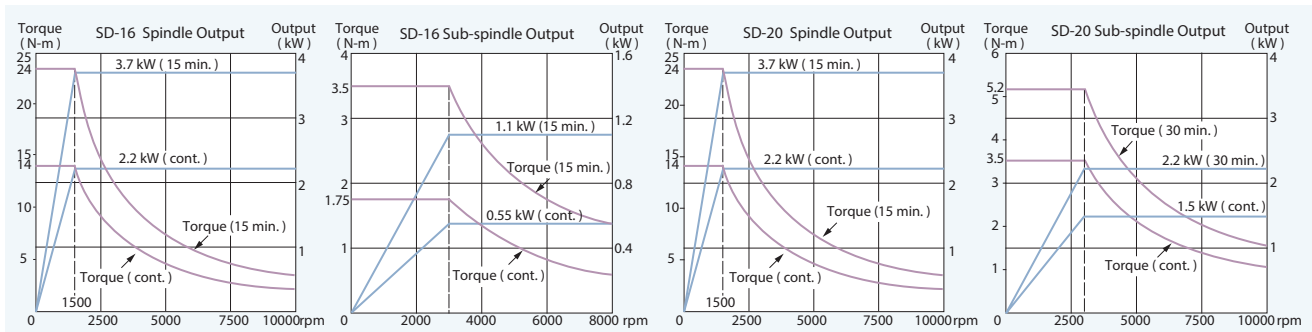

Work Range

SD-16

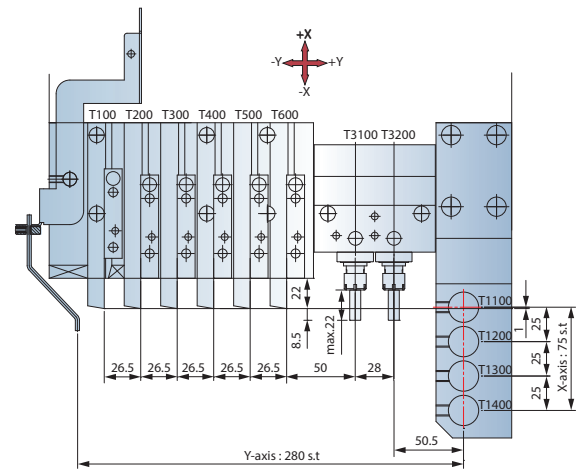
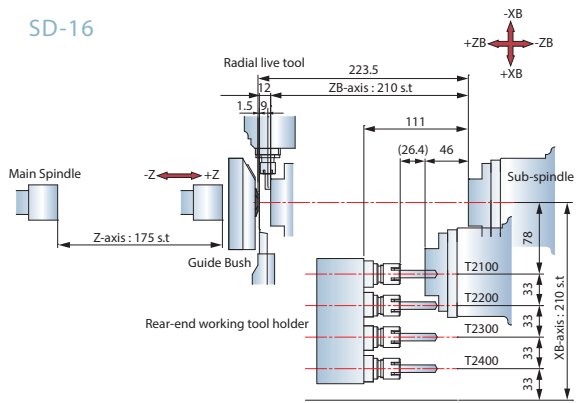

SD-20

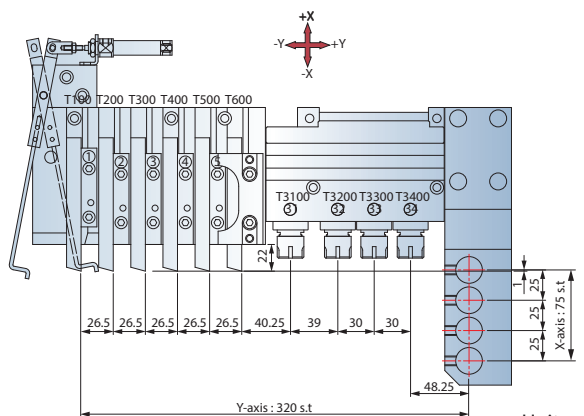
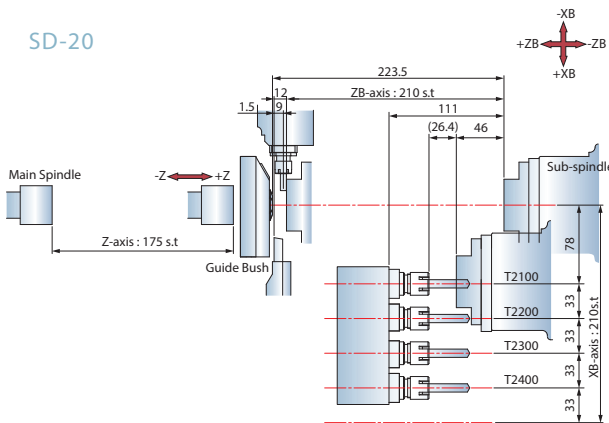

Unit : mm

SW SERIES TOOL SYSTEM

► SW series offers more flexible operations such as turning, milling and cross drilling. From a different combination of power systems, main-spindle, sub-spindle, front-end tool, rear-end tool, C-axis and live tools which means the workpiece can be finished at one time and also allows two operators to be machined simultaneously.

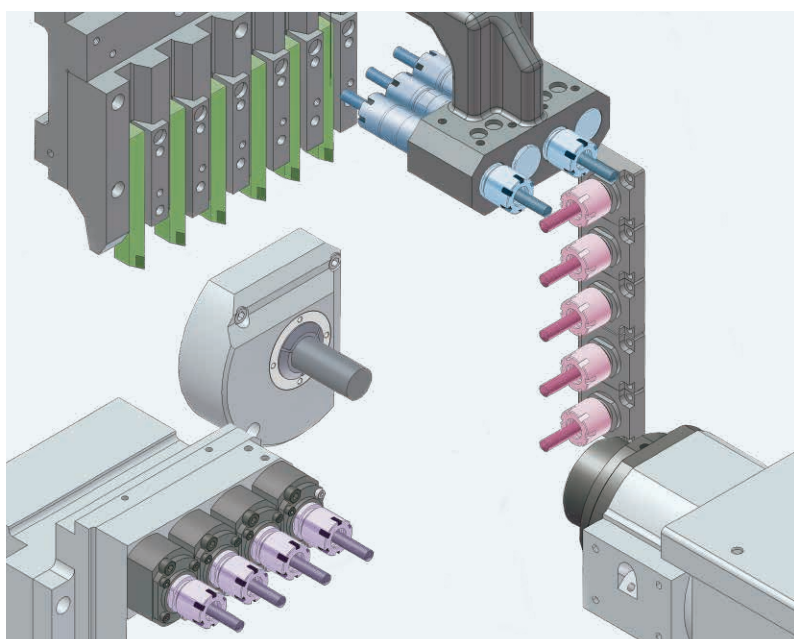
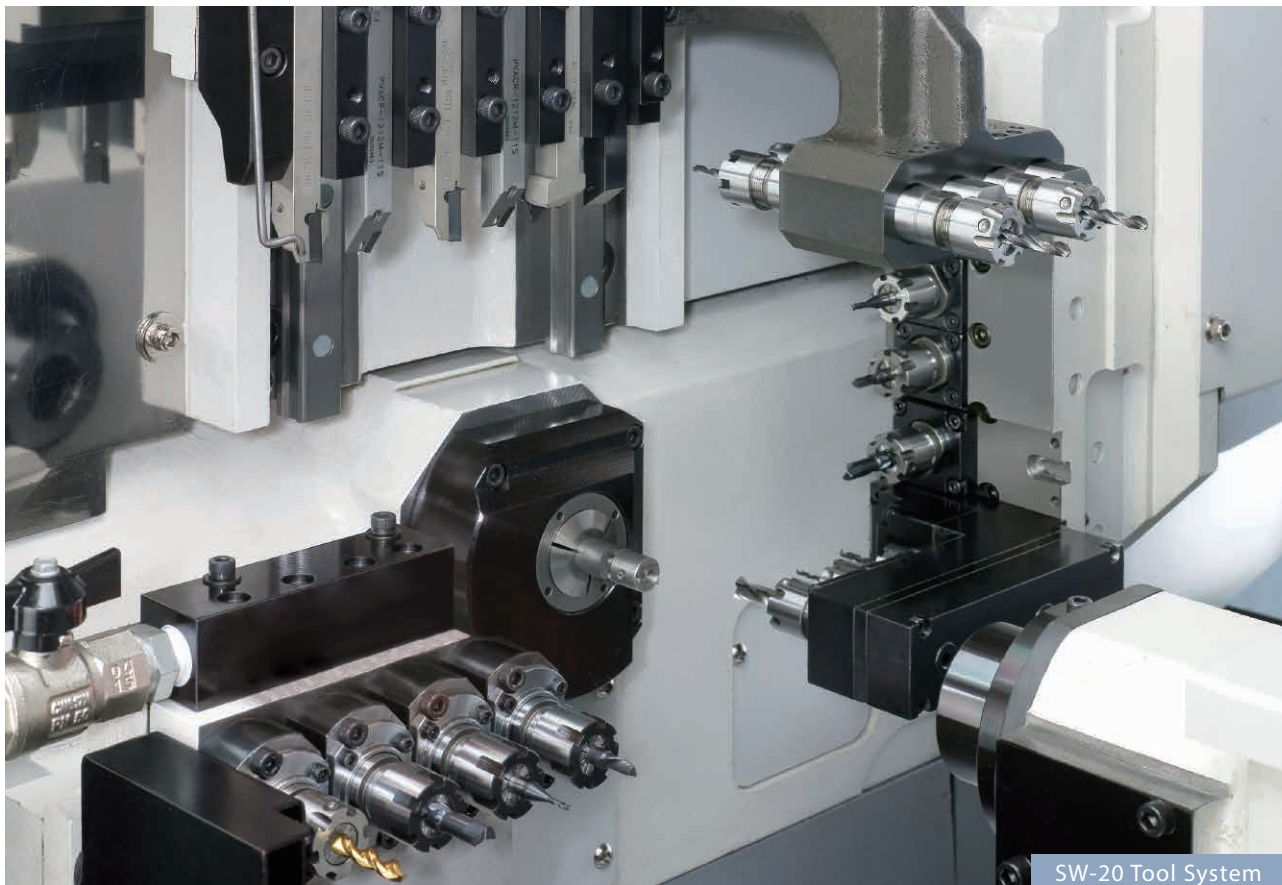

- O.D. Tool
- I.D. Tool
- Radial Live Tool
- Rear Live Tool

TOOL POST

Tooling System	SW-20 / 32	SW-42	
O.D. tool	6	5	6
Front-end working tool	4	5	5
Rear-end working tool	4	5	5
Radial live tool* ₁	5 (Max.)	4	5
Axial live tool* ₂	5 (Max.)	5	5
Rear-end Tooling System			
Rear-end working tool*	4	4	4

*1 The upper 3 positions are a fixed unit for milling and drilling and the bottom 2 positions allow variations to be fitted. (For SW-20 / SW-32)

The upper 2 positions are a fixed unit for milling and drilling and the bottom 2 positions allow variations to be fitted. (For SW-42)

*2 The bottom 2 positions can be increased up to 5 front-end and 2 rear-end live tools.

*3 Live tools are available.

SPINDLE CONSTRUCTION

- ▶ Spindle can be exchange to be bush type or bushless type which is depend on different work requirements.
- ▶ The bushless design which is suitable for machining cold forge bar and the remain bar can be less than 70 mm to save material cost.
- ▶ The bush type use belt drive from spindle with high speed which can less surface damage and efficient increase working performance.
- ▶ SW-32 / SW-42 spindle uses rotary hydraulic cylinder which can firmly clamp the workpiece. The rotary hydraulic cylinder provides fast response and flexible clamping force advantages.

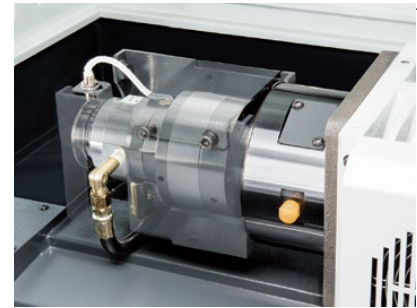

Bush type spindle configuration

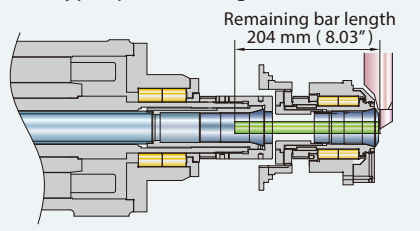

Bushless type spindle configuration

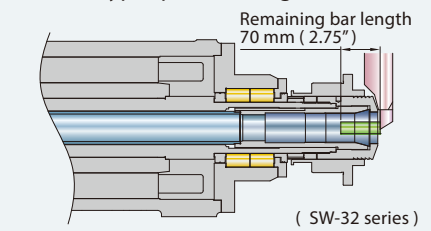

Model	Bush type	Bushless type	Module
SW-20	S	—	O
SW-32	—	—	S
SW-42	—	S	—

S: Standard O: Option —: Not Available

Spindle Output

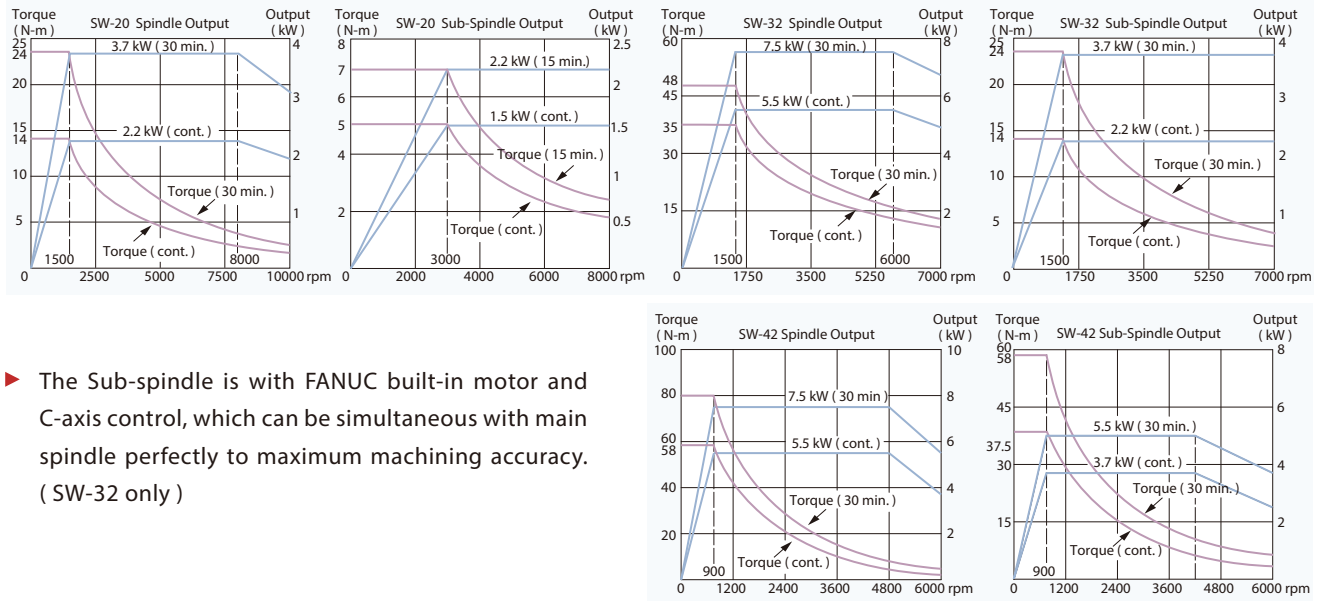

- ▶ The Sub-spindle is with FANUC built-in motor and C-axis control, which can be simultaneous with main spindle perfectly to maximum machining accuracy. (SW-32 only)

U-Drill Device

- ▶ Sub-spindle applied 2 U-Drill devices which can increase tool number and make tool selection more flexible. (SW-32 only)
- ▶ Based on different application, the side rotary toolholder can select different live tool attachment, such as for OD grooving, polygon machining or standard rotary toolholder.
- ▶ All axes are using high accuracy linear guide way to ensure the most stabilize and provide ultra high performance in moving and positioning. Beside, guide way are pre-load to eliminate any backlash occurs during high speed moving.

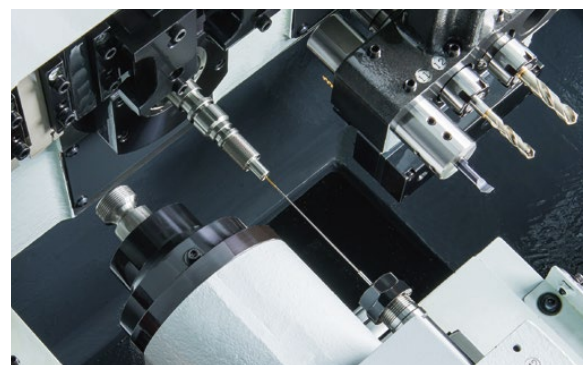

Work Range

SW-20

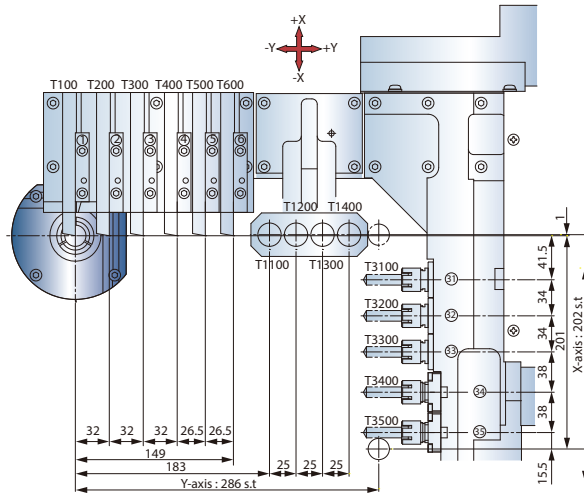
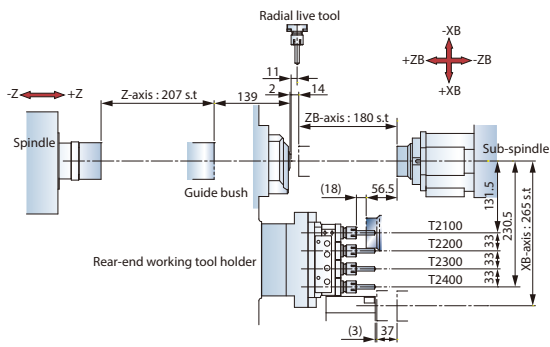

SW-32

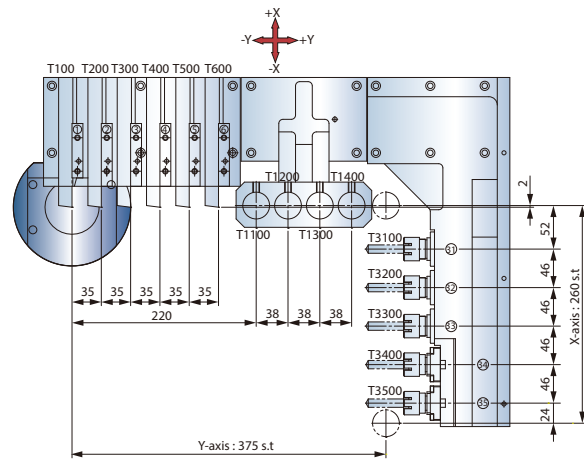
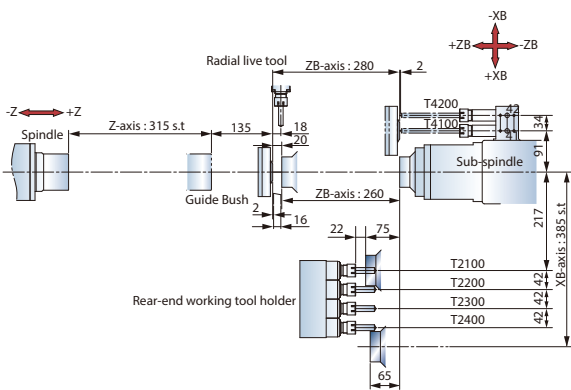

SW-42

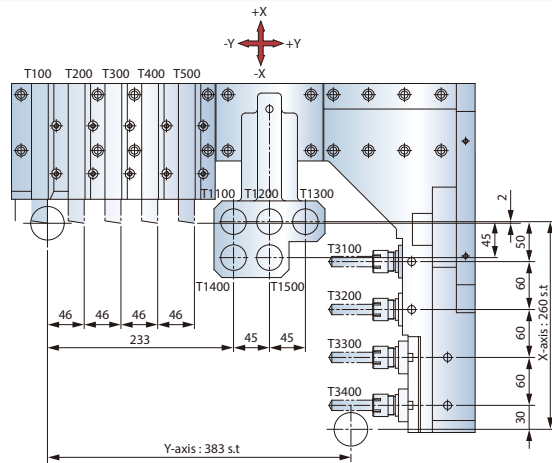
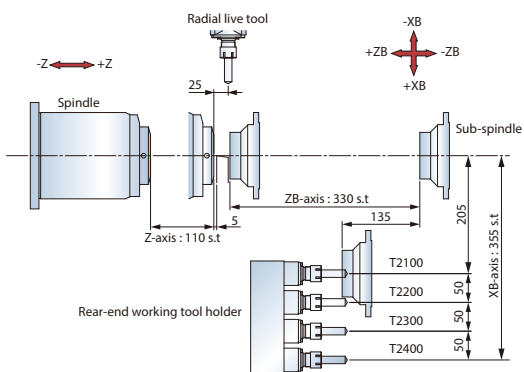

SW-42 [5-axis side milling]

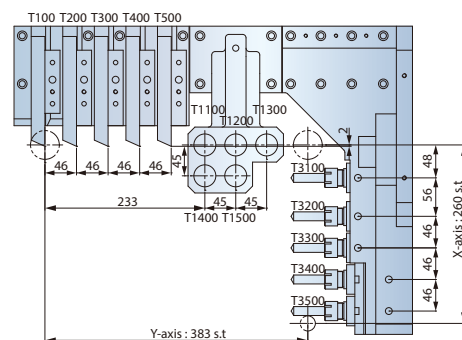
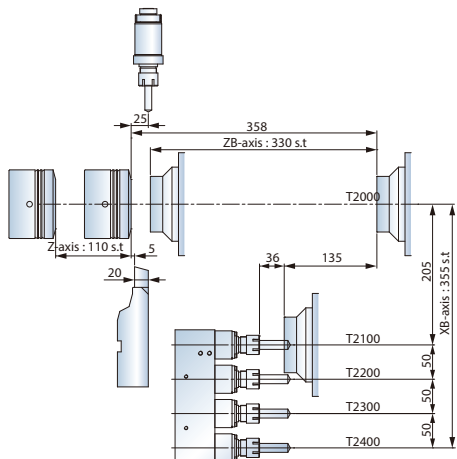

MACHINE LAYOUT

SD-16 / SD-20

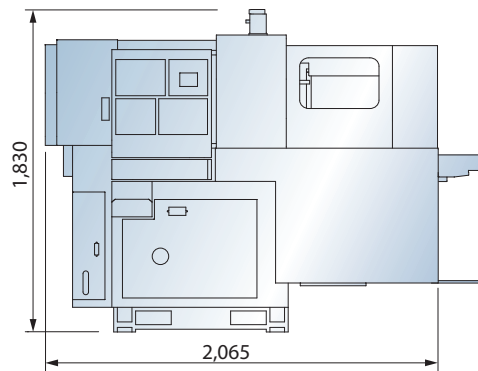
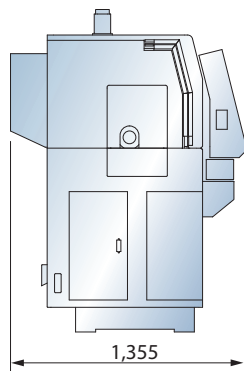

SW-20

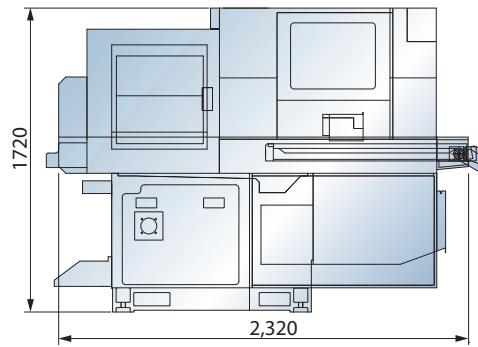
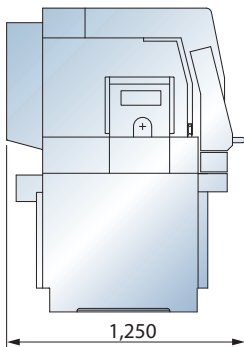

SW-32

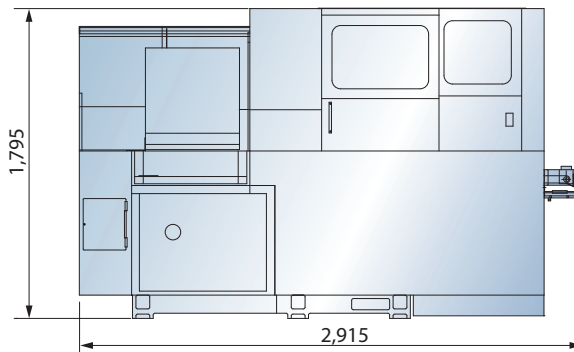
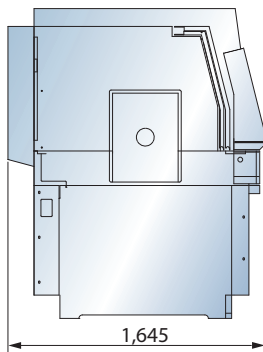

SW-42

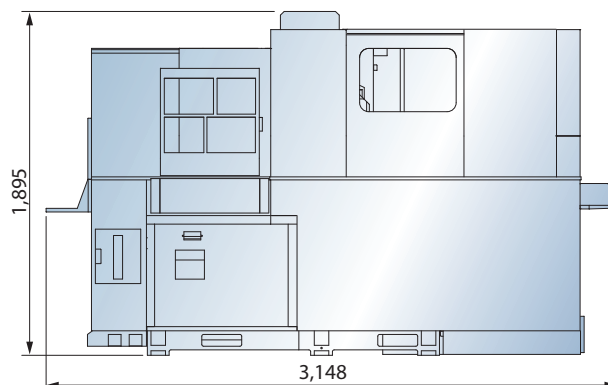
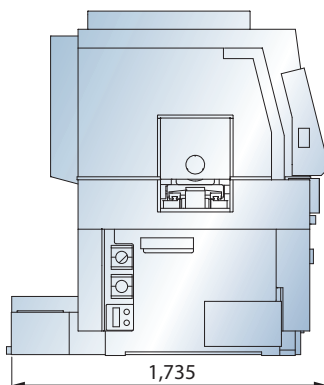

STANDARD & OPTIONAL FEATURES

S : Standard O : Option
 - : Not Available C : Contact Goodway

	SD-16	SD-20	SW-20	SW-32	SW-42
SPINDLE					
Main spindle motor configuration	S	S	S	S	S
Rigid tapping	S	S	S	S	S
C-axis	S	S	S	S	S
Spindle brake	S	S	S	S	S
WORK HOLDING					
Spindle hardness collect	O	O	O	O	O
Spindle tungsten collect	O	O	O	O	O
Sub-spindle hardness collect	O	O	O	O	O
Sub-spindle tungsten collect	O	O	O	O	O
Special work holding chuck	O	O	O	O	O
GUIDE BUSH					
Stationary guide bush	O	O	O	O	-
Revolving guide bush	S	S	S	S	-
Rotary Magic guide bush	O	O	O	O	-
Tungsten guide bush	O	O	O	O	-
COOLANT					
Coolant pump	S	S	S	S	S
High-pressure coolant system	5.0 MPA	O	O	O	O
	7.0 MPA	O	O	O	O
Roll-out coolant tank	S	S	S	S	S
Oil skimmer	O	O	O	O	O
Coolant flow switch	S	S	S	S	S
Coolant level switch	S	S	S	S	S
CHIP DISPOSAL					
Chip conveyor with auto timer	O	O	O	O	O
Chip cart with coolant drain	O	O	O	O	O
Oil mist collector	O	O	O	O	O
POWER-DRIVE TOOL					
ER16 milling unit	-	-	O	O	-
ER16 3-spindle front drilling unit	-	-	O	O	-
ER16 2-spindle front drilling unit	-	-	O	O	-
ER16 slotting holder	-	-	O	O	-
ER16 3-spindle drill / milling holder (0 ~ 360°)	-	-	O	O	-
ER16 live tool for back	-	-	O	O	-
ER20 milling unit	-	-	-	O	O
ER20 3-spindle front drilling unit	-	-	-	O	O
ER20 2-spindle front drilling unit	-	-	-	O	O
ER20 slotting holder	-	-	-	O	O
ER20 3-spindle drill / milling holder (0 ~ 360°)	-	-	-	O	O
ER20 live tool for back	-	-	-	O	O
Thread whirling unit for outer	-	-	O	O	O
Polygon machining unit	-	-	O	O	O
AUTOMATIC OPERATION SUPPORT					
Bar feeder	O	O	O	O	O
Bar feeder interface	S	S	S	S	S
Parts catcher	S	S	S	S	S
Work piece transport conveyor	S	S	S	S	S
Long parts ejector	O	O	O	O	-
Sub-spindle parts eiector device (pneumatics)	O	O	O	S	S
Sub-spindle coolant through spindle	-	-	O	O	O

	SD-16	SD-20	SW-20	SW-32	SW-42
SAFETY					
Fully enclosed guarding	S	S	S	S	S
Door interlock (incl. Mechanical lock)	S	S	S	S	S
Impact resistant viewing window	S	S	S	S	S
Low hydraulic pressure detection switch	-	-	S	S	S
Over travel (soft limit)	S	S	S	S	S
Load monitoring function	O	O	O	O	O
Cut off detector	S	S	S	S	S
OTHERS					
Tri-color operation status light tower	S	S	S	S	S
Florescent work light	S	S	S	S	S
Electrical cabinet	A/C cooling system	O	O	O	O
	Heat exchanger	S	S	S	S
Complete hydraulic system	-	-	S	S	S
Complete pneumatic system	S	S	S	S	S
Advanced auto lubrication system	S	S	S	S	S
Maintenance tool kit	S	S	S	S	S
Operation & maintenance manuals	S	S	S	S	S

S : Standard O : Option
 - : Not Available C : Contact Goodway

		O _i -TD	31 _i
FANUC CONTROL FUNCTIONS			
PMC	25n sec/step	S	S
Display	8.4" color LCD	S*1	-
	10.4" color LCD	O	S
Graphic function		S	S
Full keypad	Large - 56 keys	S	S
	320 K	-	-
	512 K	S	-
	Part program storage length		
O _i - TD : each path 31 _i - : total	1,024 K	-	S
	2 M	-	O
	4 M	-	O
	8 M	-	O
Registerable programs O _i - TD : each path 31 _i : total	400	S	-
	1,000	-	S
	64	S	-
Tool offset pairs O _i - TD : each path 31 _i - : total	99	O	S
	200	-	O
	400	-	O
Servo control	HRV2 (3)	S	S
Run hour & parts counter		S	S
Auto power off function		S	S
Custom macro B		S	S
RS-232 port		S	S
Memory card input/output		S	S
Embedded ethernet (10 BASE)		S	S
Fast ethernet (100 BASE)		O	O

Specifications are subject to change without notice.

*1 Only applicable for SD-16 / SD-20 series

MACHINE SPECIFICATIONS

Model			SD-16	SD-20	SW-20	SW-32	SW-42
Working range	Max. machining diameter		Ø 16 mm	Ø 20 mm	Ø 20 mm	Ø 32 mm	Ø 42 mm
	Max. turning length per chuck	Bush	175 mm	175 mm	207 mm	315 / 80 mm	110 mm (Bushless)
		Bush / Bushless	–	–	120 / 50 mm		
O.D. tools	Number of tools		6 / 5 (Opt.)	6	6	6	5
	Size		□ 12 mm	□ 12 mm	□ 12 mm	□ 16 mm	□ 20 mm
I.D. tools	Number of tools		4	4	4	4	5
	Sleeve size		ER 16	ER 16	ER16	ER 20	ER 20
	Max. drilling capacity		Ø 10 mm	Ø 10 mm	Ø 10 mm	Ø 13 mm	Ø 13 mm
	Max. tapping capacity		M8 x P1.25	M8 x P1.25	M8 x P1.25	M12 x P1.75	M12 x P1.75
	Max. end Mill capacity		Ø 7 mm	Ø 10 mm	Ø 10 mm	Ø 13 mm	Ø 13 mm
Side live tool	Number of tools		2 / 3 (Opt.)	4	5 ~10	5 ~10	4 ~6
	Max. speed		8,000 rpm	6,000 rpm	8,000 rpm	6,000 rpm	6,000 rpm
	Servo motor output		0.4 kW	1.0 kW	1.2 kW	1.4 kW	1.4 kW
	Sleeve size		ER 11	ER 16	ER 16	ER 20	ER 20
	Max. drilling capacity		Ø 6 mm	Ø 8 mm	Ø 8 mm	Ø 10 mm	Ø 10 mm
	Max. tapping capacity		M5 x P0.8	M6 x P1.0	M6 x P1.0	M8 x P1.25	M8 x P1.25
	Max. end Mill capacity		Ø 7 mm	Ø 10 mm	Ø 10 mm	Ø 13 mm	Ø 13 mm
	Max. speed		10,000 rpm	10,000 rpm	10,000 rpm	7,000 rpm	6,000 rpm
Main spindle	Spindle motor output		2.2 / 3.7 kW	2.2 / 3.7 kW	2.2 / 3.7 kW	5.5 / 7.5 kW	5.5 / 7.5 kW
	Min. indexing increment		0.088°	0.088°	0.001°	0.001°	0.001°
Axes rapids			30 m/min	30 m/min	30 m/min	30 m/min	30 m/min
NC control			FANUC Oi-TD	FANUC Oi-TD	FANUC 31i	FANUC 31i	FANUC 31i
Spindle center height			1,075 mm	1,075 mm	1,060 mm	1,060 mm	1,080 mm
Coolant tank capacity			140 L	140 L	150 L	170 L	170 L
Machine dimensions (mm)			2,065 x 1,355 x 1,830		2,385 x 1,250 x 1,730	2,915 x 1,645 x 1,795	2,880 x 1,375 x 1,940
Machine weight			2,000 Kg	2,100 Kg	2,300 Kg	3,200 Kg	3,300 Kg

Rear-end Machining

Model		SD-16	SD-20	SW-20	SW-32	SW-42	
Rear-end machining capability	Max. chucking diameter	Ø 16 mm	Ø 20 mm	Ø 20 mm	Ø 32 mm	Ø 42 mm	
	Max. length for front ejection	80 mm	80 mm	80 mm	130 mm	110 mm	
	Max. parts projection length	30 mm	30 mm	30 mm	50 mm	50 mm	
Back working tooling	Number of tools		4	4	4	4	4
	Max. speed		–	–	8,000 rpm	5,000 rpm	5,000 rpm
	Servo motor output		–	–	0.4 kW	0.75 kW	0.75 kW
	Drilling capacity (Dead)		Ø 8 mm	Ø 8 mm	Ø 8 mm	Ø 13 mm	Ø 13 mm
	Drilling capacity (Live)		–	–	Ø 5 mm	Ø 6 mm	Ø 6 mm
	Tapping capacity (Dead)		M6 x P1.0	M6 x P1.0	M8 x P1.25	M10 x P1.25	M10 x P1.25
	Tapping capacity (Live)		–	–	M4 x P0.7	M5 x P0.8	M5 x P0.8
	Max. speed		8,000 rpm	10,000 rpm	8,000 rpm	7,000 rpm	6,000 rpm
Sub-spindle	Sub-spindle motor output		0.55 / 1.1 kW	1.5 / 2.2 kW	1.5 / 2.2 kW	2.2 / 3.7 kW	3.7 / 5.5 kW
	Min. indexing increment		–	–	0.001°	0.001°	0.001°

Specifications are subject to change without notice.



GOODWAYCNC.com

GOODWAY MACHINE CORP.

HEADQUARTERS

No.13, 5Th Road,
Taichung Industrial Park,
Taichung City, 407, Taiwan, R.O.C.
Website : www.goodwaycnc.com
E-mail : goodway@goodwaycnc.com

CENTRAL TAIWAN SCIENCE PARK BRANCH

No. 38, Keyuan Road,
Central Taiwan Science Park.Taichung,
Taichung City, 407, Taiwan, R.O.C.
TEL : + 886-4-2463-6000
FAX : + 886-4-2463-9600

GOODWAY MACHINE (WUJIANG) CO.,LTD

No. 4888, East Lake Taihu Avenue, Wujiang
Economic and Technological Development Zone,
Jiangsu, China
SALES HOTLINE : + 86-512-8286-8068
SERVICE HOTLINE : + 86-512-8286-8066
FAX : + 86-512-8286-8620
E-mail : goodway.wj@goodwaycnc.com